



REDAWN

**Reducing
Energy**

**Dependency in
Atlantic Area**

Water

Networks

Orientações para o projecto
de micro hídricas



REDAWN

**Reducing
Energy**

**Dependency in
Atlantic Area**

Water

Networks

**Orientações para o projecto
de micro hídricas**

REDAWN
Reducing Energy Dependency
in Atlantic Area Water Networks



Interreg
Atlantic Area
European Regional Development Fund



EUROPEAN UNION



Redawn collaborators



ISBN: 978-88-9784-0701

Copyright 2021 ©



Ateneapoli srl

via Pietro Colletta, 12 (80139) Napoli - Italia

www.ateneapoli.it

BOOKSTORE

www.ateneapoli.it/libri

Sommario

1. Executive Summary	9
2. Introduction	11
3. Potentiality of MHP in AA networks	15
4. Possible Use of Energy	18
Energy production with grid connection.....	18
Energy production with standalone use.....	19
Energy production for WDN monitoring and control.....	19
Energy supply to a freshwater stream.....	20
Energy supply to a wastewater stream.....	20
Energy recovery in the water supply chain.....	21
5. Existing Energy Production Devices	22
Traditional turbines.....	22
Low power/High production EPDs.....	23
Low power/Low production EPDs.....	30
Turbo-compressors.....	32
6. Network data in WDNs	35
7. Principles of MHP design	43
PAT selection in conventional MHP.....	43
Unconventional MHP.....	44
MHP layout and housing.....	49
MHP location strategy.....	51
8. Environmental benefit of MHP	55
9. Conclusions	60
10. References	61
List of Abbreviations	67

1. Executive Summary

This booklet is addressed to water and energy managers, policy makers and technicians working in water transportation and distribution of different industrial sectors, like public drinking water, irrigation and water-intensive industry. The basic guidelines for the installation of Micro Hydro Power (MHP) in water networks in the Atlantic Area (AA) of Europe are defined, introducing a strategy for reducing the energy dependency in AA water networks. As a starting point the opportunities and new technologies to recover the potential energy that is available in man-made water networks (such as those used for public drinking water, irrigation, wastewater collection, and process industry operations) are examined. Then, all the aspects of MHP design are also examined, including the best location of the plant in the network, the best plant configuration for the specific site, the possible use of energy in the specific location, the historical data that are necessary for the design, the best Energy Production Device (EPD) to be selected for the specific site, the control of the EPD and the design of auxiliary piping. All these points are crucial to maximize the exploitation of the excess pressure or head, otherwise wasted, which will be partially or totally converted to electrical power, using the best available technology. A partial energy conversion is generally required when small amounts of energy are required on site, as in the case of a monitoring and control station of a water distribution network. On the contrary, a total energy recovery is suitable when the MHP is connected to the electric grid. In this case, the MHP will replace a traditional pressure reducing valve, optimizing the pressure in the downstream part of the network, without affecting the normal operation of the network. A PAT (Pump as Turbine) is generally considered the best available technology for this last kind of application: the REDAWN project demonstrated the large potential of PAT technology to foster the energy efficiency of AA. The economic viability of the plant was

Sumário executivo

O projeto REDAWN
demonstrou o
grande potencial da
tecnologia PAT para
promover a
eficiência energética
de área Atlântica
(AA).

found to be strictly connected to an optimal MHP design, leading to the maximum amount of primary natural sources that can be saved – especially in terms of water for the reduction of leakage connected to the pressure reduction strategy – and to the largest amount of produced energy.

2. Introduction

There is a large diffusion in water distribution networks of manual or automatic valves used to reduce the excess pressure in a part of the network. Why does the network experience a non-uniform pressure head? This is the first question that needs an answer. A second question is related to the use of Pressure Reducing Valves (PRVs). Why must an excess pressure be contained?

If we consider the simplified sketch of a small part of the network of Figure 1, we will observe that the variability of the pressure head is determined by two factors. First, the ground elevation and the building height is quite variable and the pressure head at the end users reflects this variability. Second, the energy grade line decreases with the distance from the water source as an effect of the flow resistances, determining a reduction of the pressure head in the periphery of the network.

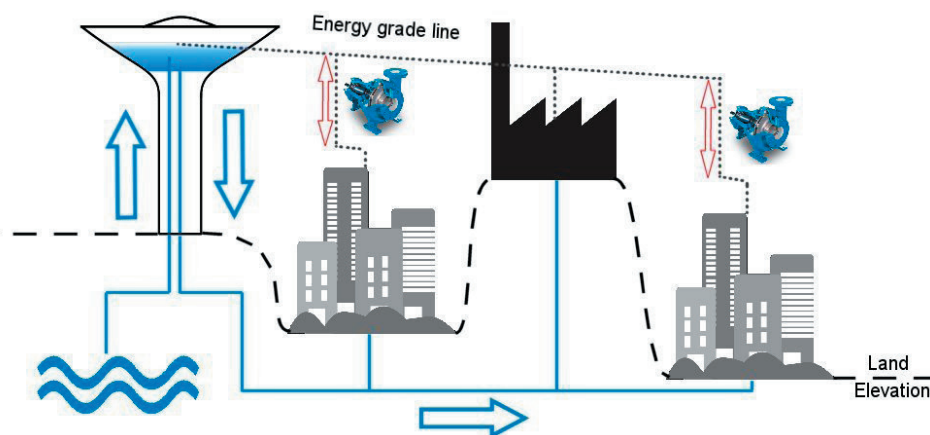

Figure 1. Typical water network locations for MHP energy recovery (Novara, D. Hydropower Energy Recovery Systems: Development of Design Methodologies for Pump-as-Turbines in Water Networks. PhD Thesis Sept 2019. University of Dublin, Trinity College).

Introdução

Uma pressão maior que o valor mínimo exigido pelos consumidores é considerada hoje em dia uma condição de funcionamento desfavorável.

A pressure larger than the minimum value required by the end users is considered nowadays to be an unfavourable operating condition. The limitation of the excess pressure to reduce leakage during the water transportation is a real challenge for water utilities. Statistics in Europe, referred to years 2012-2015, show that the amount of leakage is varies considerably from one country to another, with a mean value of 23% (Figure 2). For the Interreg AA nations the water losses range approximately between 20% and 30%.

Instead of a general replacement of the oldest pipelines, two strategies are generally accepted to reduce leakage: the creation of District Metered Areas (DMAs), in order to balance the water pressures and to make accurate resource balance, and the pressure reduction strategy, where the pressures in the network are reduced to minimize the water leakage. In both the strategies, manual, motorised or pneumatic valves are located in selected points of the network in order to reduce the pressure.

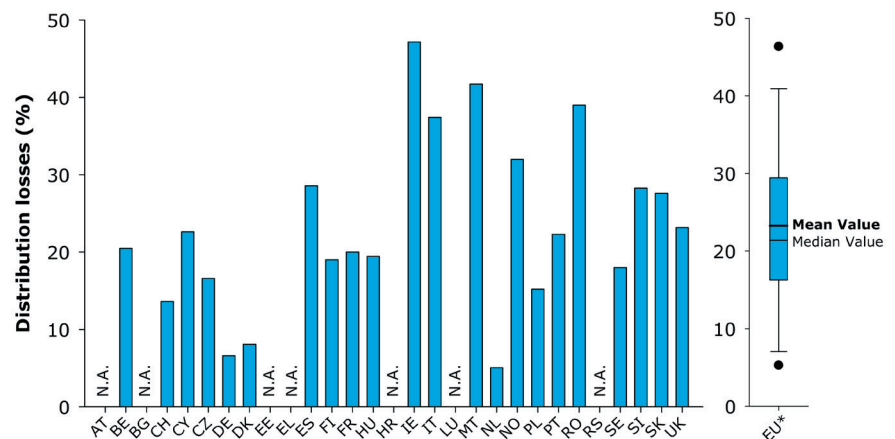

Figure 2. Water distribution losses in EC countries in the 2012-2015 period (<https://www.eureau.org/resources/publications/1460-eureau-data-report-2017-1/file>)

A key issue facing MHP exploitation in the water networks is represented by the Best Available Technology (BAT) to be used in the plants. The choice is connected to a series of conditions and design constraints.

A Water Supply Network (WSN) can be divided into a Water Transmission network (WTN) and a Water Distribution network (WDN), as shown in Figure 3. In a WTN the water is transferred from the source to several storage tanks located in proximity of each town or village; in a well-designed network the flow rate and the available drop for energy production have limited daily fluctuation and the available power is frequently larger than 20-30 kW. Instead, in a WDN the water is transferred from the storage tanks to the end users by a complex system of pipelines; the flow rate and available drop for energy production have large daily fluctuation, determined by the users' demand, and the available power is smaller than 10 kW. MHP in the WTN can be realized using the design criteria of the larger power plants, including traditional turbines as the EPDs. The only problem is represented by the complexity of the connection to the electric grid and by the absence of energy users in the production point. On the contrary, micro- and pico-hydropower plants in WDNs have a completely different layout, for the necessity of reducing the plant costs, in the presence of very small revenues. In addition, the energy production does not represent the main goal of the WDN managers, the reliability of the network being the most important aspect of the water transportation and distribution.

A produção de energia não representa o objetivo principal dos gestores das redes de distribuição (WDN), sendo a confiabilidade da rede o aspecto mais importante do transporte e distribuição de água

O projeto de um
micro hídrica
(MHP) nas redes
de água (WDNs)
é condicionado por
uma série de fatores
igualmente
importantes

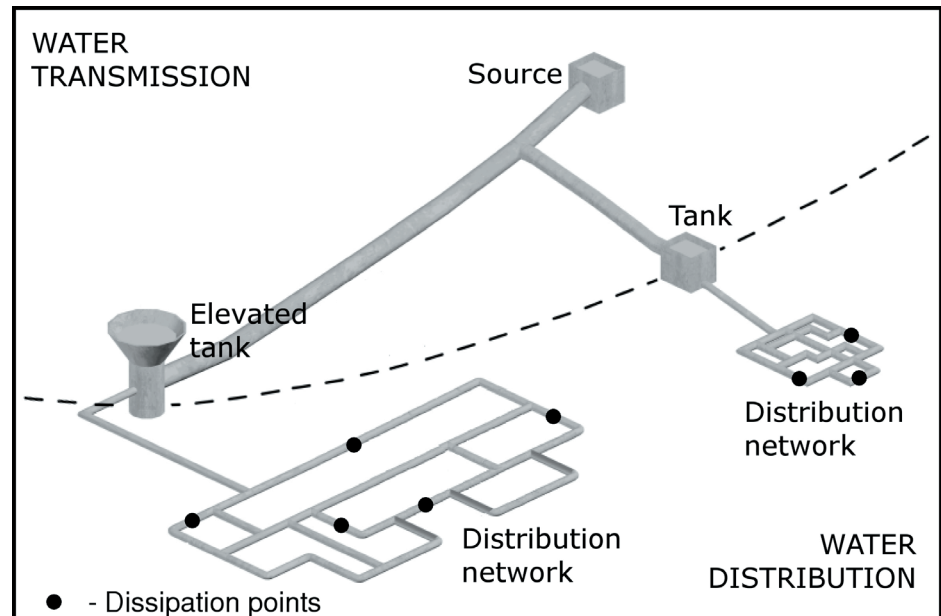

Figure 3. Sketch of a Water Supply Network

In conclusion, the design of a MHP in the WDNs is forced by the following factors:

- the location of the MHP is not determined by the economic impact of the plant itself, but by the economic impact of a more complex management strategy;
- the specific cost of the MHP has to be reduced, compared to traditional plants, for the small available power;
- the main concern of the water manager is the reliability of the water service and the technology of the MHP has to be reliable too;
- the lack of a possible use of the produced energy is frequently a real limitation for the MHP construction.

3. Potentiality of MHP in AA networks

The REDAWN project quantified the energy resource potential of water networks across the AA. This study was performed for the different industrial sectors (public water, irrigation, wastewater and water-intensive industry) and required a detailed investigation of the excess hydraulic power available in the networks of the AA at a local scale, an estimate of the excess energy passing from the local to the regional scale, an evaluation of the efficiency of the BAT for MHP, and a computation of the energy resource potential at the national scale. This work presents valuable information which can facilitate the full exploitation of the MHP technology, in all aspects: device production, network management, and policy making.

An example of the methodology used for the assessment of the energy resource potential in the case of irrigation is shown in Figure 4. Starting from a number of available network topologies, a preliminary MHP design is performed and the amount of energy recovery is estimated at a number of sites with excess pressure within the networks. Then, by a transfer function calibrated on the crop and climate characteristics, the benefit is extended to the regional scale. A similar process was created for the WDNs for urban water distribution, for the recovery of the energy dissipated in the PRVs. Similar processes were also followed for the wastewater and industry network sectors.

Figure 5 shows the MHP energy recovery potential of Irish sites, Northern Irish sites, Scottish sites and Welsh sites. For the industrial sector, the potential of the MHP technology was estimated by finding the available head drops at the outlet of the water treatment plants and by calculating the corresponding energy production.

Potencial de micro
hídricas (MHP) em
redes de água da
zona Atlântica (AA)

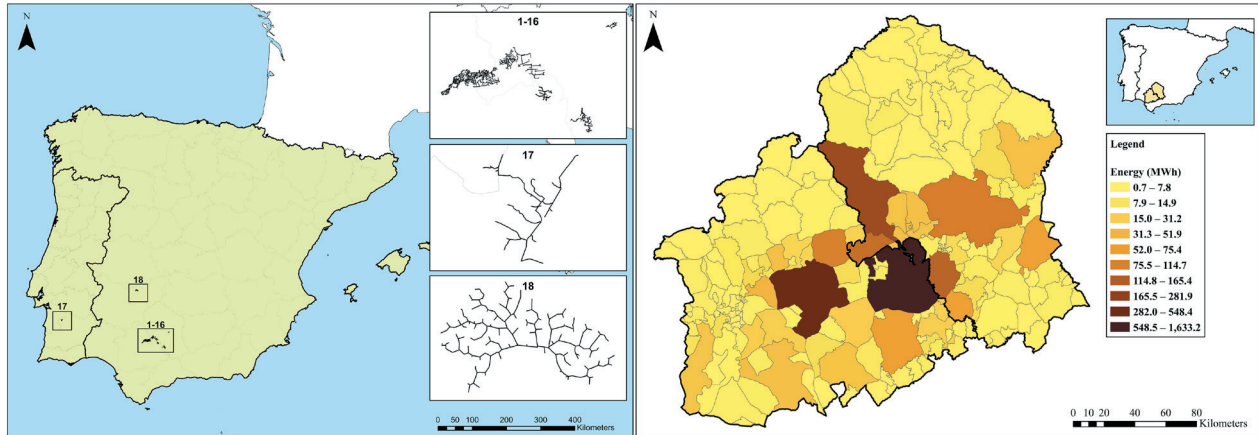

Figure 4. Evaluation of the MHP potential in the irrigation network of Andalusia (<https://doi.org/10.1016/j.renene.2020.03.143>)

A Figura 5 mostra o potencial de recuperação de energia MHP em locais da Irlanda, da Irlanda do Norte, da Escócia e do País de Gales

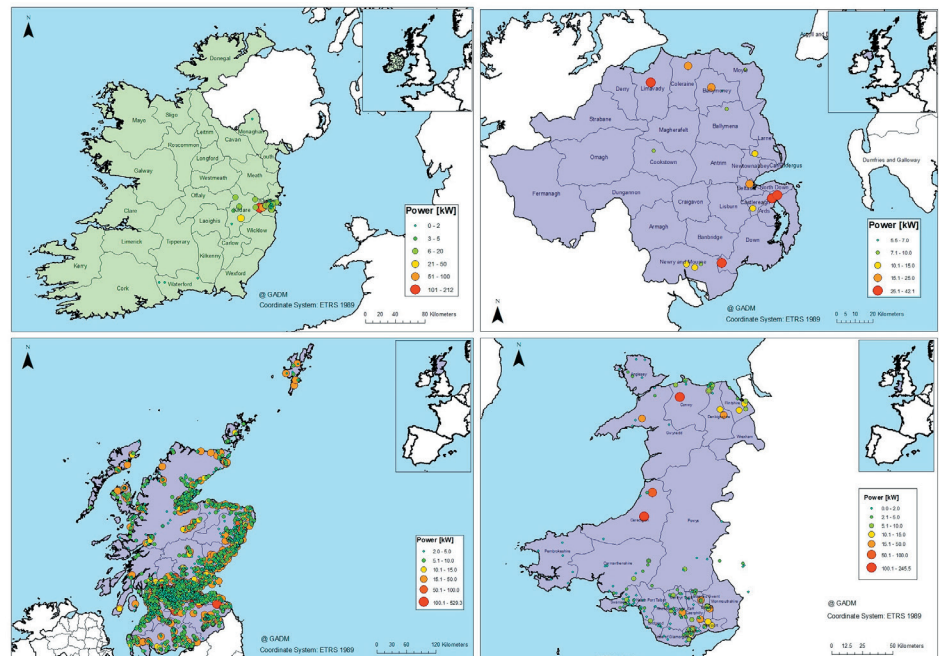

Figure 5. Evaluation of the MHP potential in northern AA urban water networks (Irish sites, Northern Irish sites, Scottish sites and Welsh sites) (<https://doi.org/10.3390/w13070899>)

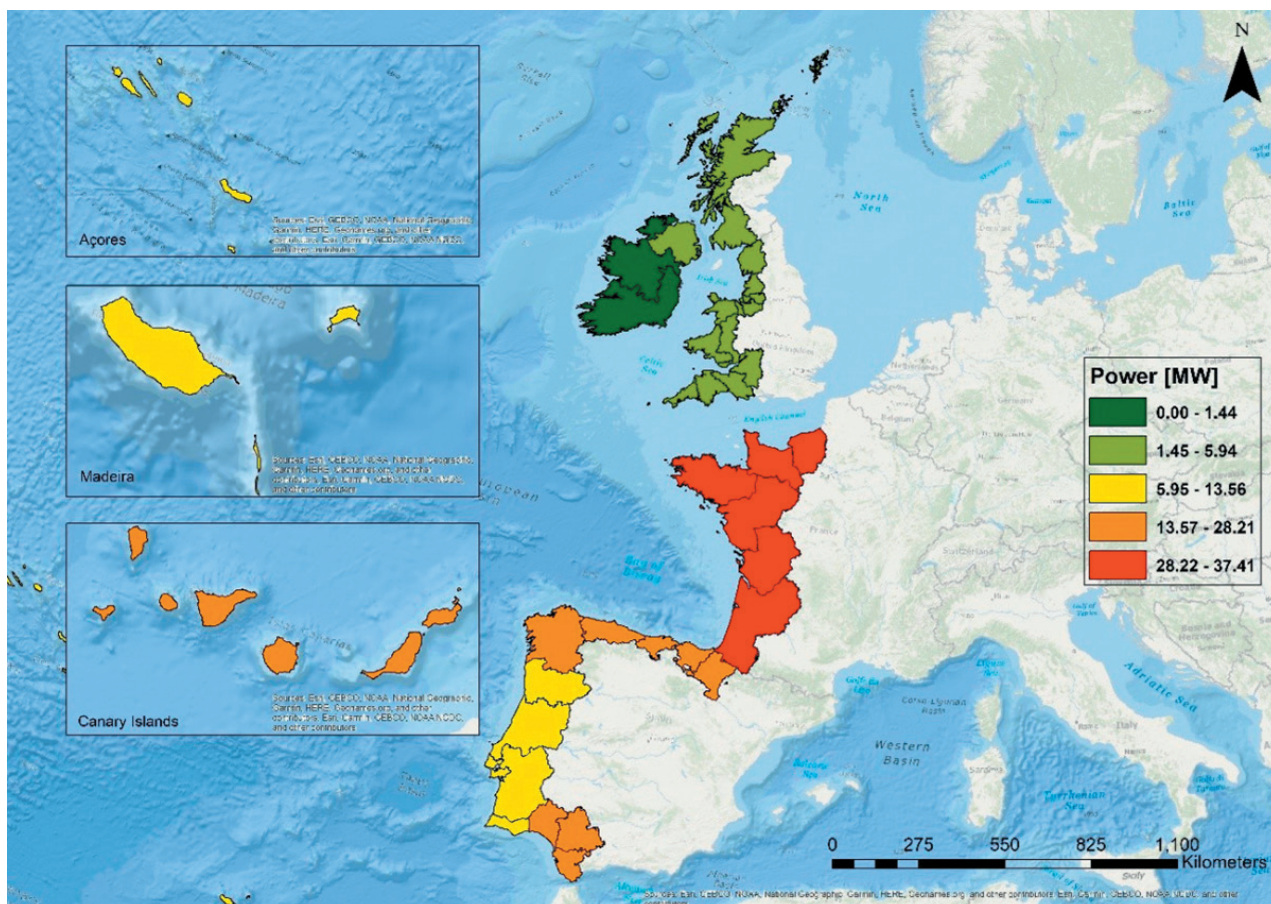

Figure 6. Total energy recovery potential estimated for the whole AA region

In Figure 6 the total energy recovery potential estimated for the whole AA region is represented. The data are compiled in a GIS platform showing the spatial distribution of energy resources in the AA. The data can be accessed on the REDAWN website (<https://www.redawn.eu/>).

Na Figura 6 apresenta-se o potencial total de recuperação de energia estimado para toda a região Atlântica (AA).

4. Possible Use of Energy

The last factor cited in the introduction, that is the use of energy, must be considered the starting point of the MHP design. Without a clear idea of the potential value of the energy it is impossible to make a correct viability analysis, in the absence of reliable data for the MHP income. Considering that the pressure reduction of the flow is strictly related to the energy exchange with the generator, the electric energy has to be somehow used. This is the reason why a large effort in the REDAWN project was made in identifying and studying several unconventional schemes for the use of this energy. We can summarize and discuss the following possibility for an energy use in the WDNs:

1. energy production with grid connection
2. energy production with standalone use
3. energy production for WDN monitoring and control
4. energy supply to a freshwater stream
5. energy supply to a wastewater stream
6. energy recovery in the water supply chain

Energy production with grid connection

This is the classical solution for MHP installation. In this case, the EPD can be equipped with an asynchronous generator and the energy recovered in the plant will supply the electric grid. This solution is usually possible in the WDN of public drinking water system of urbanised areas for the presence of a diffused energy distribution. The small installed power of WDN power plants compared to the electric power distributed to the end users makes the connection to the grid very easy, for the stability of the electric waveform and of the energy demand of the grid.

In these kinds of MHPs the primary goal of the design is the con-

straint given by the backpressure value imposed by the water managers. The secondary goal is the plant reliability. The third goal is the plant profitability.

Energy production with standalone use

When the MHP is installed in a peripheral part of the WDN of a public drinking water system or in a rural site served by the WDN of an irrigation system, the connection to the electric grid is frequently impossible or not economically viable. In this case, the best alternative is to find local end users. Obviously, the matching between the MHP locations and the end user locations is not easy to obtain. Frequently, this pairing is obtained, but the power adsorbed by the end user is smaller than the one offered by the MHP, and the size of the plant has to be reduced.

An alternative is represented by the creation of a new commercial activity in the MHP site using energy at a convenient tariff. As an example, the energy recovered in the plant could be used to charge batteries of different power, based on the MHP potentiality, from car size batteries, requiring few kW, to phone batteries, requiring less than 100 W.

Energy production for WDN monitoring and control

With the increase of the WDN monitoring, control and automation, there is the necessity of supplying energy to small stations located in selected point of the network, where the main parameters of the flow are measured, data are sent to a centralized network control centre and a valve is remotely controlled. These stations, when they are located in a remote site, are not connected to the electric grid and an alternative needs energy supply. Unfortunately, the power required

Em micro hídricas (MHPs) ligadas à rede elétrica, o objetivo principal do projeto é a restrição dada pelo valor da pressão a jusante (que era conseguido por válvulas redutoras de pressão) imposto pelos gestores de água. O objetivo secundário é a fiabilidade da instalação. O terceiro objetivo é a rentabilidade da instalação.

É comum nas redes de distribuição de água (WDN) que exista a necessidade de abastecimento a uma pequena zona localizado num ponto mais elevado, em comparação com o restante da rede. Nestes casos, é possível aumentar a eficiência global da central através de um acoplamento direto do eixo com a bomba.

by these stations is small and does not justify the construction of a conventional MHP. Therefore, some specific technologies are available to convert a small fraction of the hydraulic energy in electric energy to satisfy the request of the WDN monitoring and control stations. Alternatives to meet these small energy needs include solar panels and battery storage, however both have disadvantages in comparison to MHP installations.

Energy supply to a freshwater stream

It is not unusual in the WDN for the necessity of supplying water to a small district located at higher elevation to exist, compared to the elevation rest of the network. The water is supplied to these areas by pumping stations taking water from one of the tanks located along the WDN. The main stream could reach the tank with a residual energy that is merely dissipated. In these cases, it is possible to recover this energy by creating a special power plant transferring directly the residual energy of the main stream to the smaller stream directed to the small district. The conversion occurs from a low pressure–high discharge flow to a high pressure–low discharge flow. In these cases, it is possible to increase the global efficiency of the power plant by a direct coupling of the EPD with the pump. Another advantage is the reduction of the plant cost.

Energy supply to a wastewater stream

Another opportunity for an energy conversion could be present when the dissipation node is located close to a wastewater pumping station. These stations are used in the low point of the drainage network in order to pump the wastewater towards a treatment plant. In the presence of a wastewater pumping station close to the dissi-

pation node of the freshwater network, it is possible to recover the freshwater energy by coupling the MHP of the freshwater network with the wastewater pump, reducing the energy request of the wastewater network with small investment costs.

Energy recovery in the water supply chain

The energy recovery by MHP could be an important added value in the definition of new water supply chains with lower environmental impact. Water supply by direct pumping is a new strategy to ensure an optimal pressure value in the network, as an alternative to the use of elevated water tanks or reservoirs with fixed pressure levels. In the definition of the economic and environmental benefit of the indirect pumping scheme, the alternative of an energy recovery downstream of the elevated tank has to be deeply analysed. In many cases, the revenues of the MHP could change the balance of the benefits between the two supply solutions.

Even in presence of upstream treatment plants within network, as in the case of desalination plants, the energy recovery by MHP can lead to an important reduction of the water costs.

A recuperação de energia através de uma micro hídrica (MHP) pode ser um importante valor acrescentado na definição de novas cadeias de abastecimento de água com menor impacto ambiental.

5. Existing Energy Production Devices

The description of the EPDs on the market, or those in advanced stages of testing and development, can be conducted considering the above-mentioned applications.

We have been able to classify the machineries that can be used in the MHP of the water supply networks within four families:

- Traditional turbines;
- Low power/High production EPDs;
- Low power/Low production EPDs;
- Turbo-compressors.

Dispositivos de
produção de energia
existentes

Traditional turbines

The classical Francis, Pelton or Banki turbines are frequently used in Water Transmission (Figure 7). The first kind of turbine is used for power plant located along a transmission pipeline, in presence of backpressure. Francis turbines and generators are available in the market for power as small as 20 kW, but 40-50 kW can be considered the lower limit for Francis turbine applications achieving economic viability. Together with the cost of the EPD, the cost of a complex control system should be considered, allowing the automatic opening of a bypass pipeline in case of turbine malfunctioning or in presence of an electric grid anomaly.

A Pelton or a Banki turbine could be the optimal solution for recovering the residual energy at the end of a transmission pipeline, in absence of backpressure. The first turbine is suitable for medium to high head drops, while the second for small to medium head drops.



Figure 7. Traditional turbines for use in WT (from left, Francis, Pelton and Banki turbines)

Low power/High production EPDs

In the Water Distribution part of the network, the available power is smaller than 10 kW and the EPDs must satisfy a number of different criteria:

- maximize the energy production;
- reduce the pressure to an expected value;
- minimize the power plant cost;
- maximize the power plant reliability.

The expectation can be complied more easily in the main branches of the network, where the installed power is closer to the maximum, than in the peripheral part of the network, where the installed power reduces to a few kW or less. The EPDs potentially available in WDNs are following presented.

Pump as Turbines (PATs) are traditional pumps used in inverse mode (Figure 8, showing the French pilot plant developed within the REDAWN project). It is the more diffuse EPD for high power/high production in WDNs. For the fixed geometry of the impeller and in the absence of internal flow control, the use of the PAT has to be combined with a regulation system. For the low cost of equipment PATs are occasionally used also in WTNs. The advantages are the low cost, the high reliability and the diffusion on the market. PATs have been shown to be 5-15 times less expensive than

Pump as Turbines (PATs) são bombas tradicionais utilizadas no modo inverso, apresentando baixo custo, alta fiabilidade e grande disponibilidade no mercado.

the aforementioned traditional turbines within the 5-200 kW range [32]. The disadvantage is the limited power plant efficiency [24]. The PAT concept has been recently included in some industrial products, providing compact solutions with fully submersed PATs or reversible pump/PAT operation.

Figura 8. Bomba como turbina na instalação piloto do REDAWN, em França



Figure 8. Pump as turbine in REDAWN pilot plant

LucidPipe™ Power System (Figure 9) is a spherical, in-pipe hydro-power turbine that generates electricity, operating on a large diameter pipeline (24” - 60”). Each module extracts a small fraction of the stream pressure, but more modules can be installed in sequence. Target project payback of 10 years is reported, that is quite high. Applications of the technology in Riverside California and Portland Oregon (US) are reported in literature (Team, Purdue ECT, “LUCIDPIPE™ POWER SYSTEM” (2016). ECT Fact Sheets. Paper 224.

<http://dx.doi.org/10.5703/1288284316353>). The advantages are the inline displacement and the limited risk of pressure transients. The disadvantages are the large extension of the EPD housing and the high cost.

Saint-Gobain PA developed a micro turbine for drinking water supply pipeline network (Figure 10). A prototype of the turbine, with 26 kW power, was installed in 2017 in the drinking water production plant in Annonay (Fr). No additional information was obtained on the technology. The advantage is the inline displacement. The disadvantage is in the lack of information on efficiency and design data.

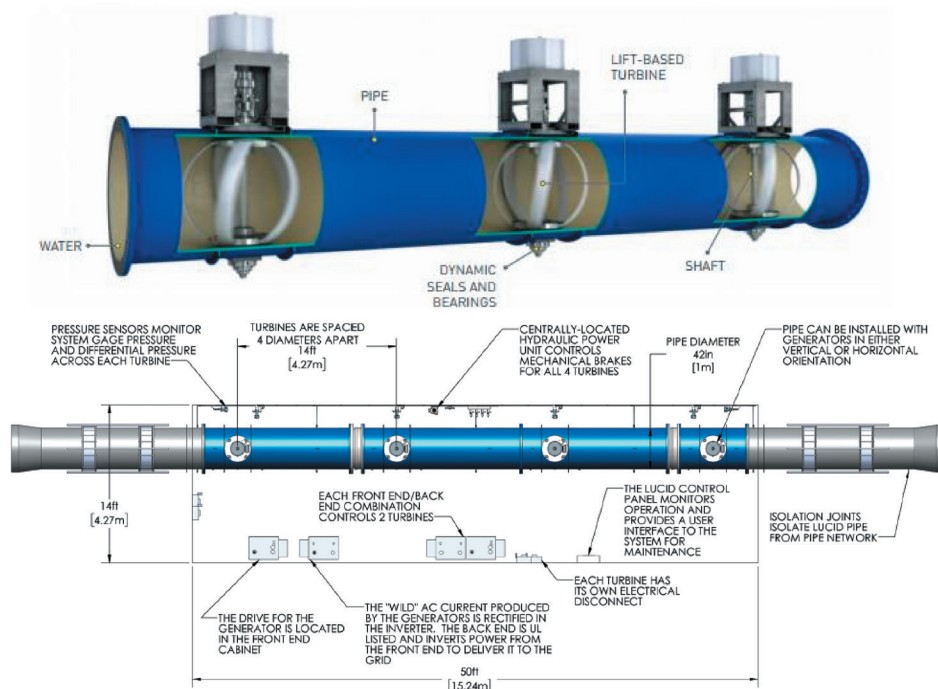

Figure 9. LucidPipe™ Power System (<https://docs.lib.purdue.edu/cgi/viewcontent.cgi?article=1224&context=ectfs>)

Figura 9. Sistema de energia LucidPipe™

Figure 10. Micro turbine Saint-Gobain PAM

LucidPipe™ Diameter (in)	Rated Power (kW)	Rated Flow (MGD)	Gauge Pressure Required for Rated output (psi)	Head Extraction at Rated (psi)	Head Extraction at Rated While Stopped (psi)	Operational Head Loss Coefficient (Running /Stopped)
24	14	24	48	5.2	1.2	6.7-8.4/2.0
42	50	64	43	5.9	1.1	7.7-10/2.3
60	100	128	43	5.0	1.2	7.7-10.1/2.3

Table 1. LucidPipe™ Power Data Overview
(<https://docs.lib.purdue.edu/cgi/viewcontent.cgi?article=1224&context=ectfs>)

A pressurized version of Pelton turbines is also available for WDNs. A traditional Pelton is installed in a closed chamber and the pressure of the air in the chamber is imposed to be equal to the required backpressure. Due to the air entrainment in the jet of water, an external ventilation system is required to maintain the pressure in the chamber. Special casing setups can be used to minimize the air flow in a counter pressure Pelton turbine. The advantage is the high turbine efficiency. The disadvantage is in the complexity of the turbine management.

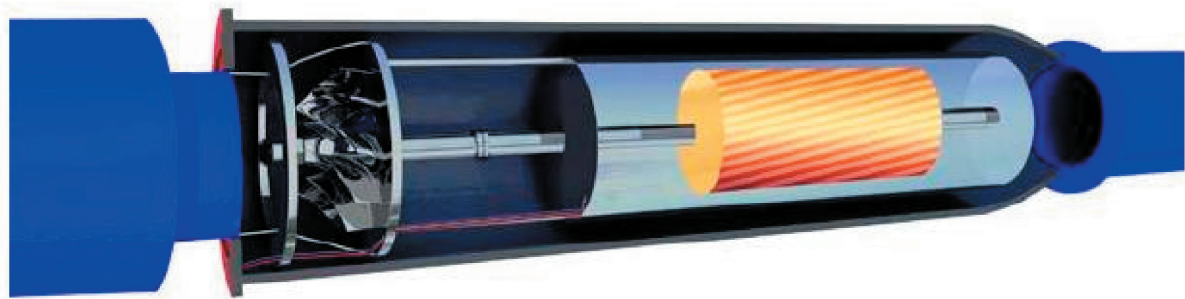

Figure 10. Saint-Gobain PAM micro turbine (https://www.saur.com/wp-content/uploads/2017/02/EN_20160103-_Saint-Gobain-PAM-_CP_Annonay_national-2.pdf)

A number of promising technologies at an advanced stage of testing are also available. These new EPDs try to overcome some of the disadvantages of the existing technologies.

A pressurized Banki-Mitchell is a promising variant of the classical channel flow turbine (Figure 11). The stream is forced to pass twice through the EPD's wheel blades, resulting in a very good energy transfer and a high efficiency in a large range of flow rates. At present the technology is not industrialized and the cost of the single unit is high (Technology Readiness Level 6).

The tubular propeller is an EPD with a special configuration of the pipeline to house a propeller turbine (Figure 12). The propeller turbine offers a free passage to the stream with an appreciable efficiency, that could be increased in large plant using variable blade geometry. The technology is not fully industrialized (Readiness Level 4).

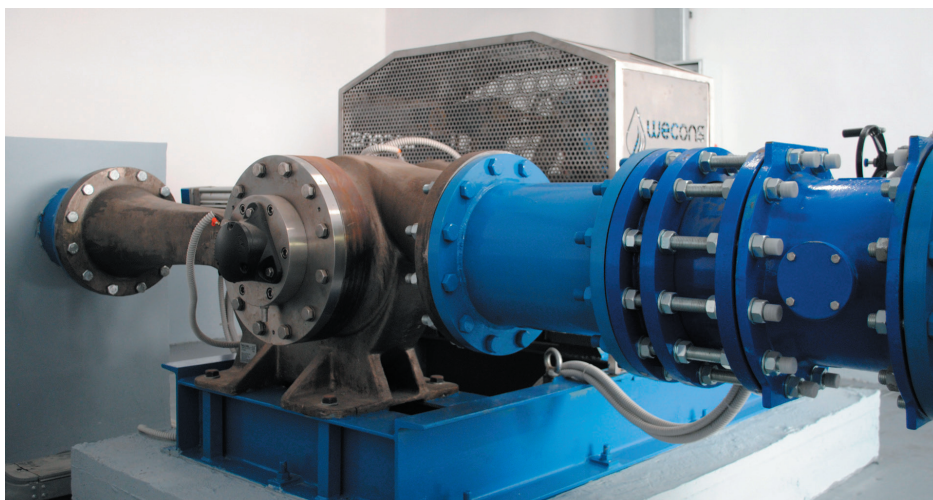

Figure 11. Pressurized Banki-Mitchell (<https://www.wecons.it/>)

Figure 11.
Banki-Mitchell com
escoamento em
pressão

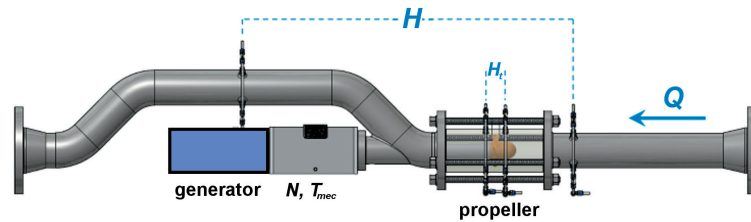

Figure 12. Tubular propeller

Figure 12. Tubular
propeller turbine
hélice tubular
desenvolvida
pelo IST

The pico-centrifugal turbine is a new EPD for in line displacement. Experiments have been performed by IST during the REDAWN project, in order to obtain a better characterization of the technology (Figure 13). The technology is not fully industrialized (Readiness Level 4).

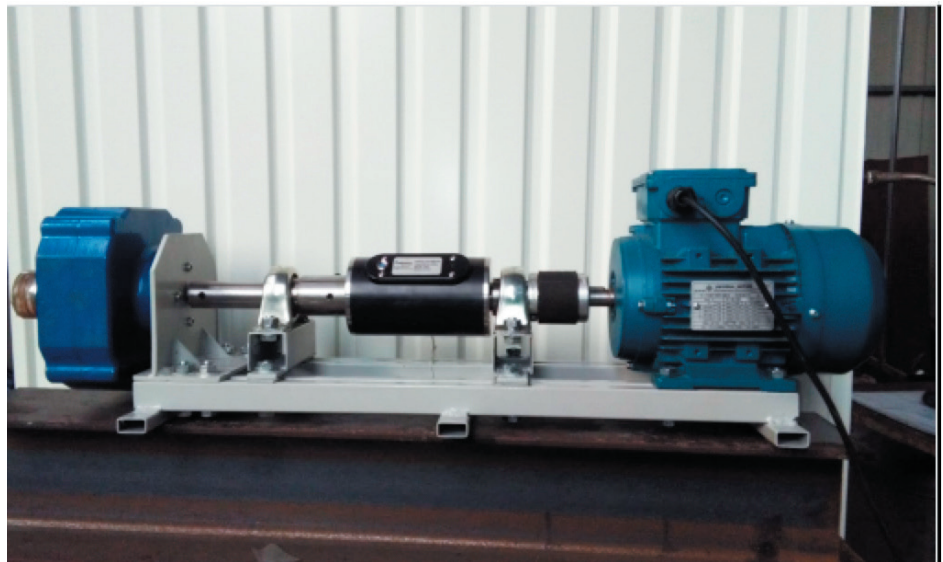

Figure 13. Pico centrifugal turbine

The Energy booster is a compact solution for energy production in WD reducing the power plant installation costs (Figure 14). One or more borehole pumps working in reverse mode are hosted in a booster, and pneumatic valves are used to adjust the flow between the two PATs and the by-pass, in order to maximize the produced energy and obtain the imposed backpressure. The technology is not fully industrialized (Readiness Level 4)



Figure 14.
Impulsionador de energia desenvolvido pela Universidade de Nápoles Federico II durante o projeto REDAWN

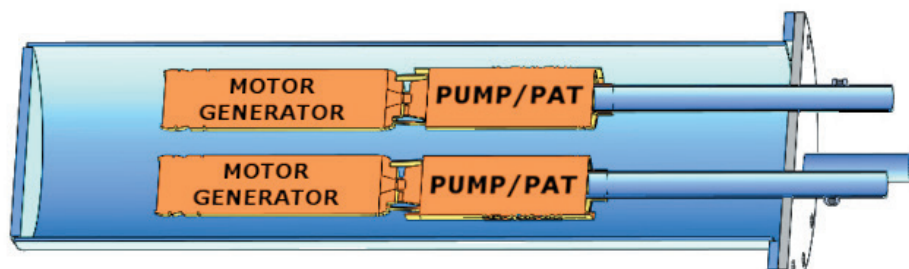

Figure 14. Energy booster

Low power/Low production EPDs

The EPDs belonging to this family are created to extract only a small fraction of the hydraulic energy of the stream. The produced energy is used to supply monitoring and control stations along the water network. The available EPDs are following presented.

The Picogen turbine is a compact EPD with a single rotating element, represented by a propeller coupled with an alternator. The EPD has the same transverse dimension of the pipeline (Figure 15). In a 200 mm duct with an average flow of 100 m³/h, a 25 W Picogen turbine can be installed, producing 0.06 bar pressure drop. Picogen is fully industrialized.

The Greenvalve is a wheel turbine hosted in the closing element of a ball valve, with an external generator (Figure 16). Energy is produced with the valve partially or completely open, without additional pressure drops. The produced energy is used for the management of the valve itself and to power monitoring devices. The technology is not industrialized (Readiness Level 4).

Figure 15.
Pico turbina

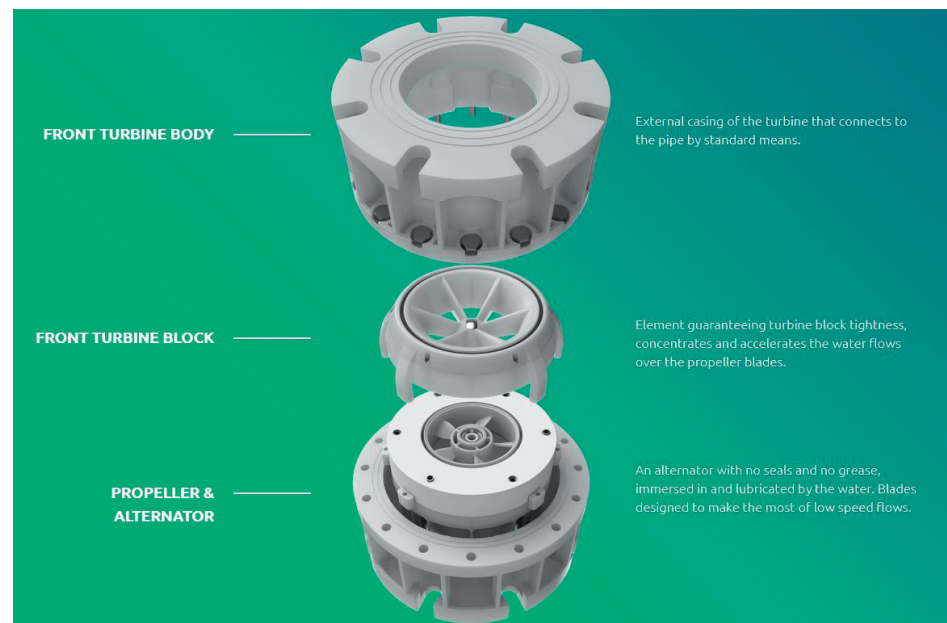

Figure 15. Picogen turbine (<https://www.save-innovations.com/picogen>)

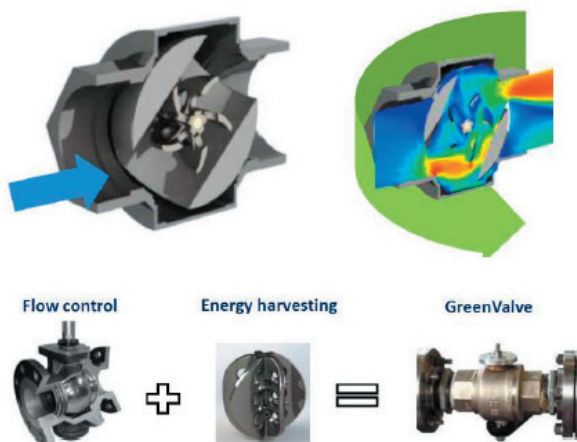

Figure 16. Green valve (<https://www.polilink.polimi.it/it/green-valve-2/>)

A number of pico turbines are also available for small energy harvesting. These EPDs are installed on a bypass pipe. These EPDs are sold in combination with the monitoring or control device. As an example, the X143IP Intermediate Power Generator, produced by Claval, can be mounted on an Automatic Control Valve as represented in Figure 17.

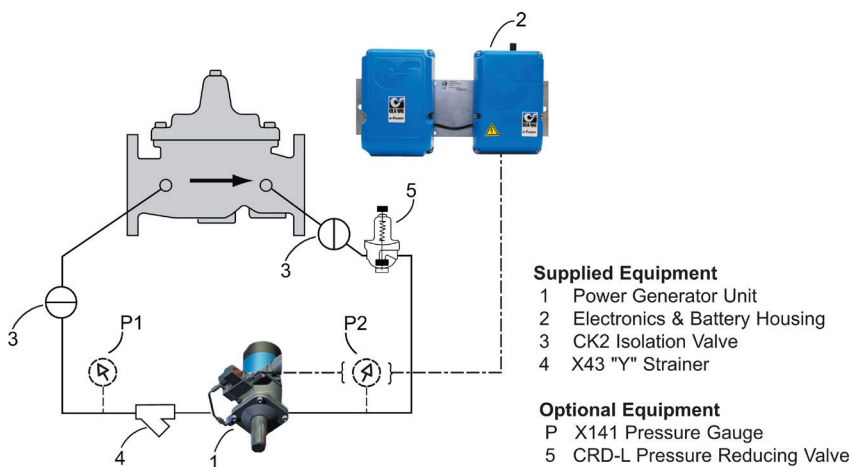

Figure 17. X143IP Intermediate Power Generator produced by Claval
 (<https://www.cla-val.com/electronic/power-generators-and-flow-meters/x143ip>)

Figure 16.
 Válvula verde

O acoplamento direto de uma PAT com uma bomba é a solução mais barata para transferir a energia hidráulica de um fluxo para outro, viável para as redes de água.

Turbo-compressors

These devices are created to transfer the hydraulic energy from one flow stream to another. This solution has a larger diffusion in other industrial sectors, like in ship engineering or in desalination plants. Hence, turbo-compressors with very different design, efficiency and costs can be found on the market.

The direct coupling of a PAT with a pump is the cheapest solution, perfectly viable for the water networks (see Figure 18). Another advantage of this kind of turbo-compressors is the possibility of covering with the pumps on the market the whole range of possible working conditions

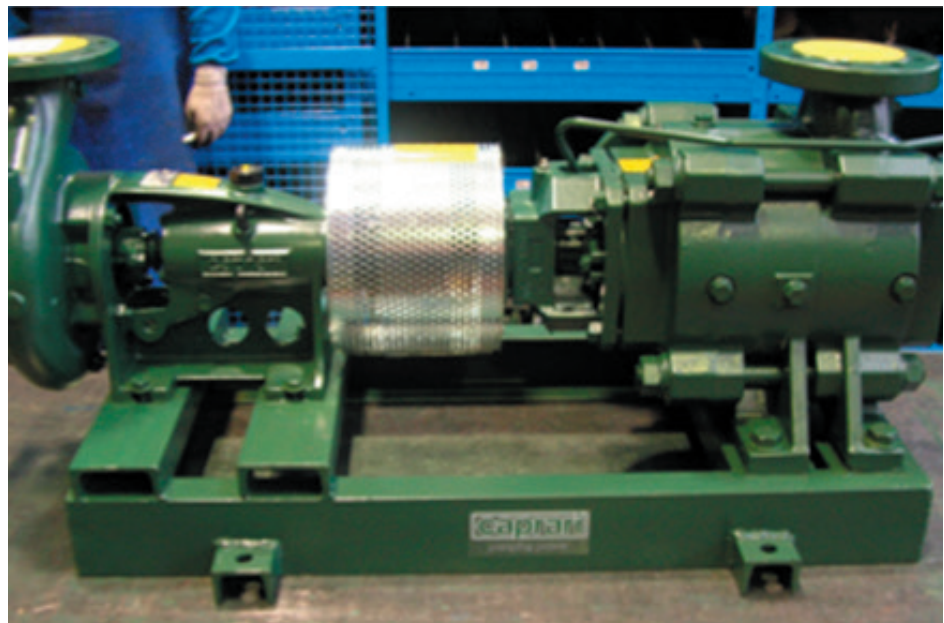

Figure 18. PAT and pump direct coupling

Turbochargers are turbo-compressors containing the turbine and pump impellers in a same body (see Figure 19). These devices were first used in the late 1980s and more widely adopted in the 1990s in the naval and industrial mechanics, but are not in production at present.



Figure 19. Turbocharger

Pressure exchangers are the top efficiency turbo-compressors used to recover energy in the desalination plants (see Figure 20). Two different working principles are used, based on an alternative piston movement, or on a rotatory pressure exchange movement. Efficiency can be as high as 98%. The cost of pressure exchangers is too high for a real use in water networks.

Turbocompressores
contêm a turbina e os
impulsores da bomba
num mesmo corpo,
mas não existe no
mercado

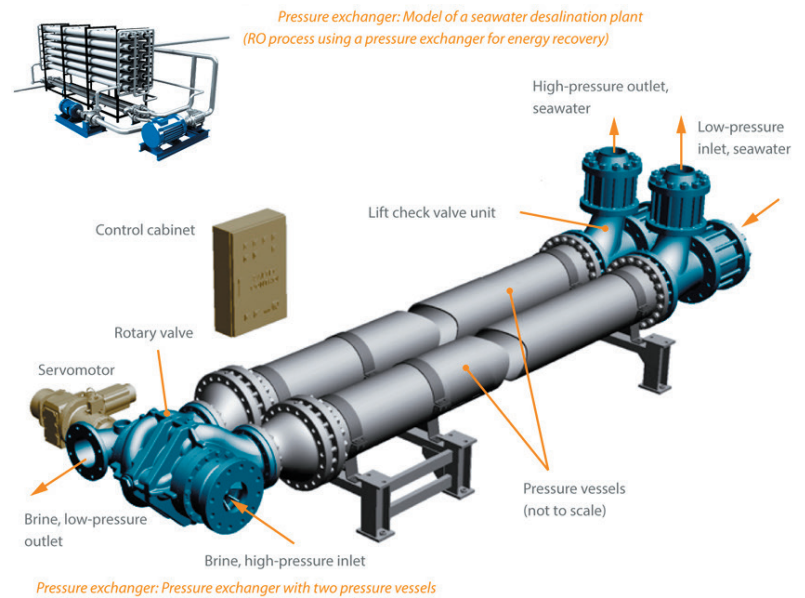
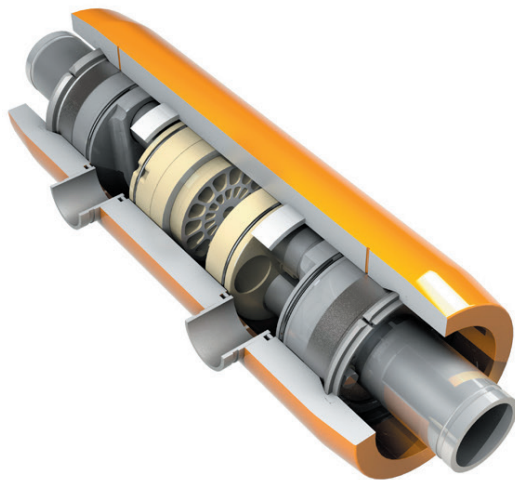

Pressure exchanger: Pressure exchanger with two pressure vessels

Figura 20.
 Transmissores
 de pressão

Figure 20. Pressure exchangers (<https://energyrecovery.com/water/px-pressure-exchanger/> and <https://www.ksb.com/centrifugal-pump-lexicon/pressure-exchanger/191730/>)

6. Network data in WDNs

The importance of creating a large database of hydraulic conditions in the water networks for water managers has been largely studied in literature. A classical hierarchy of a decision tree for a water supply system is reported in Figure 21.

Any change of the system status has to be considered as a part of a proactive process, based on historical context data, future contexts data and objectives (see Figure 22). The implementation of these management processes for the location, design and installation of MHP could seem unnecessarily complex, but this is not the case. Despite the importance of energy recovery, the plants construction is in general planned within a broad strategy with more important targets. Energy recovery is a kind of positive side effect in a pressure reducing strategy for leakage reduction.

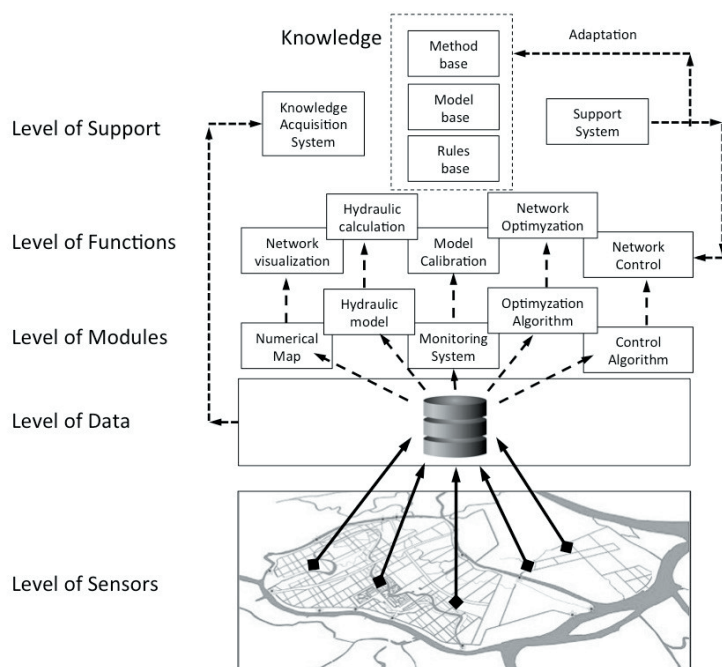

Figure 21. Decision tree of a Water Supply System (WSS) – (<https://doi.org/10.3390/w12113278>).

Dados da rede de distribuição de água (WDNs)

Os dados para o projeto de uma micro hídrica (MHP) numa rede de distribuição de água devem ser de

dois tipos:

1. Dados para um modelo hidráulico da rede;
2. Dados medidos em um local específico.

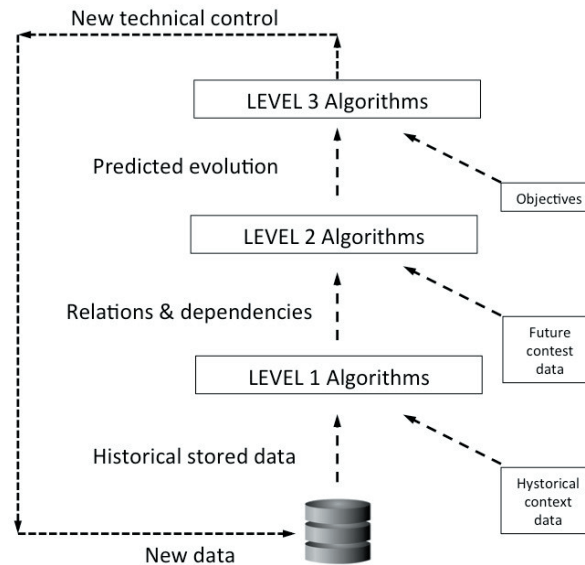

Figure 22. Reference proactive architecture for a network modeling and control (<https://doi.org/10.3390/w12113278>)

The data for the design of an MHP in a water distribution network should be of two types:

1. Data for a hydraulic model of the network;
2. Measured data in a specific site.

The first kind of data are used for the selection of valve and MHPs location and design in the network, while the second kind of data are used for the replacement of an existing PRV with a MHP. In all cases, it is important to underline that the presence of the MHP affects also points of the network displaced at large distance from the dissipation node (see Figure 23). The check of the plant functionality has to be performed with reference to the critical pressure node. Measured or calculated flow rates and pressures in the MHP node must be available at an hourly scale to account for the demand va-

riability in the WD. The effect of the seasonal variation of the user demand should be evaluated too. In Figure 24 and Figure 25, flow rates and pressures measured at a PRV in a network of SMPGA (Fr) are reported. The head drop available for the energy conversion is represented by the difference DH between the upstream and downstream pressure values at the PRV.

The basis for the MHP design is represented by the two plots of Figure 26 and Figure 27, representing the $DH(Q)$ plot and the frequency distribution of the stream power dissipated by the PRV.

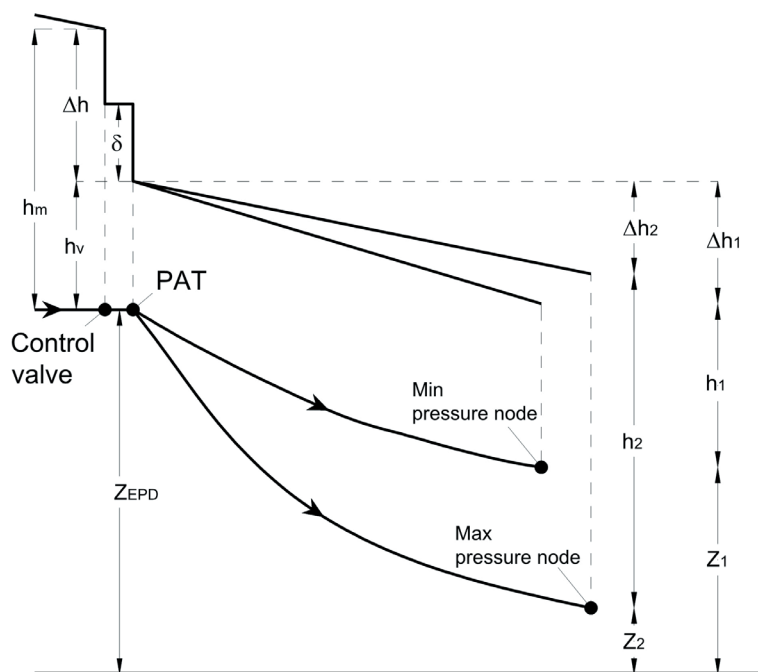

Figure 23. Effects of the PAT on the minimum pressure node
([https://doi.org/10.1061/\(ASCE\)WR.1943-5452.0000384](https://doi.org/10.1061/(ASCE)WR.1943-5452.0000384)).

Figura 23. Efeitos de uma PAT no nó de pressão mínima

Valores de caudal e pressão numa válvula redutora de pressão (PRV) medidos na rede da SMPGA (Fr) durante o projeto REDAWN, são apresentados nas Figuras 24 e 25

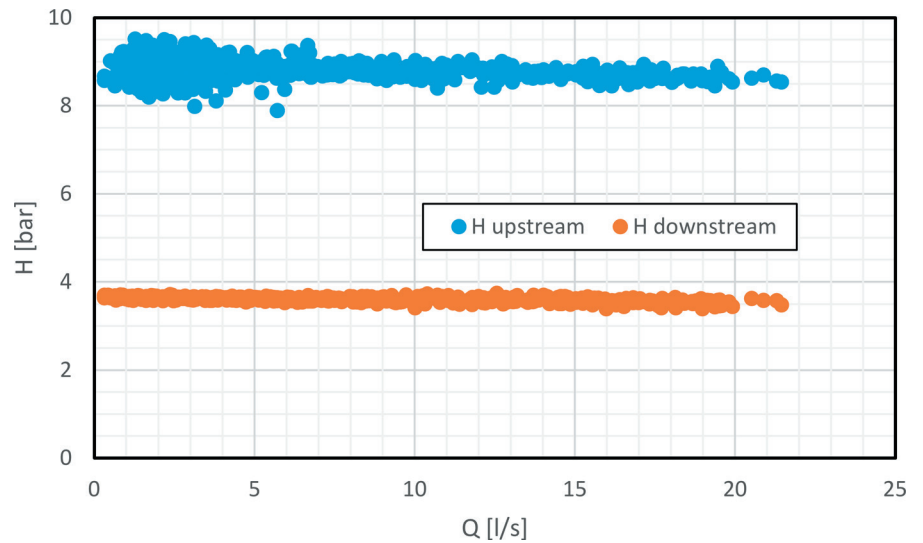

Figure 24. Pressures at the PRV site

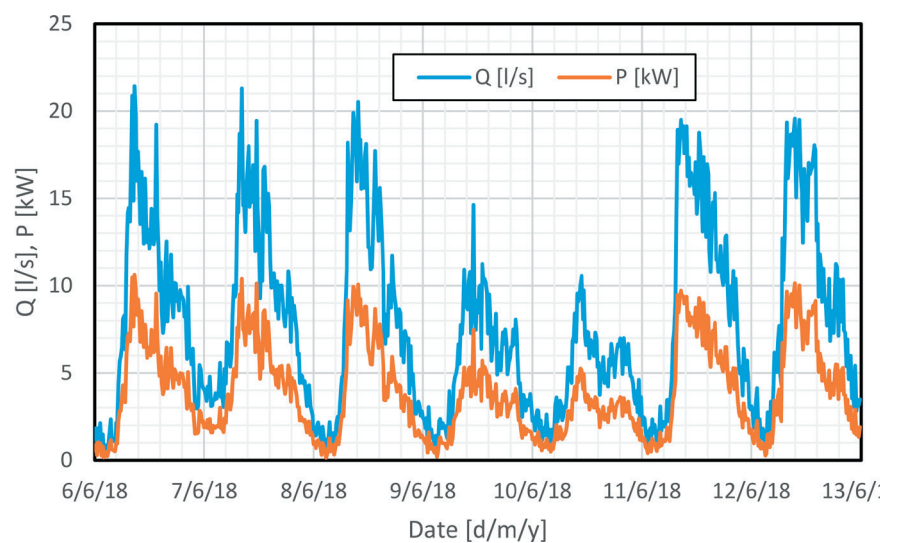

Figure 25. Flow rate and available power distribution

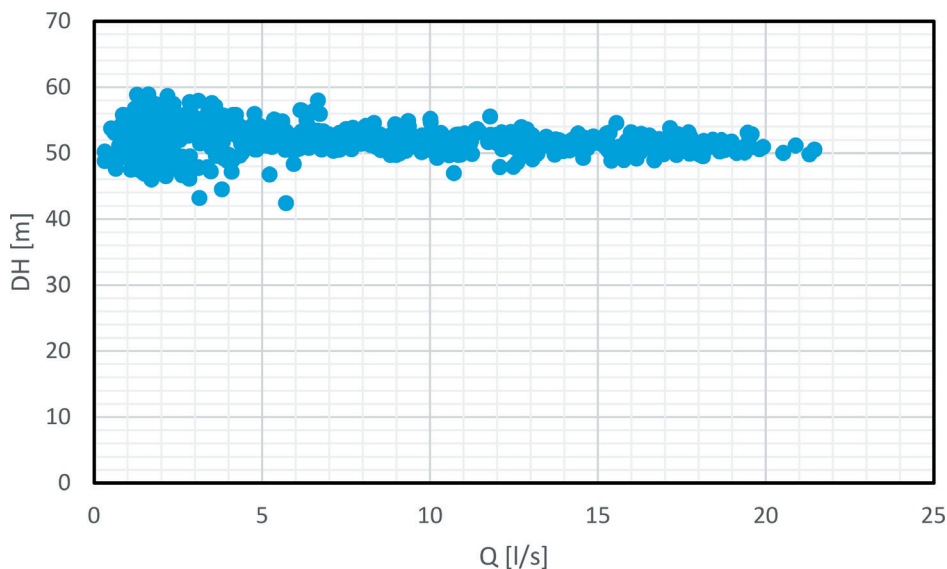

Figure 26. Head drop vs flow rate at the PRV site

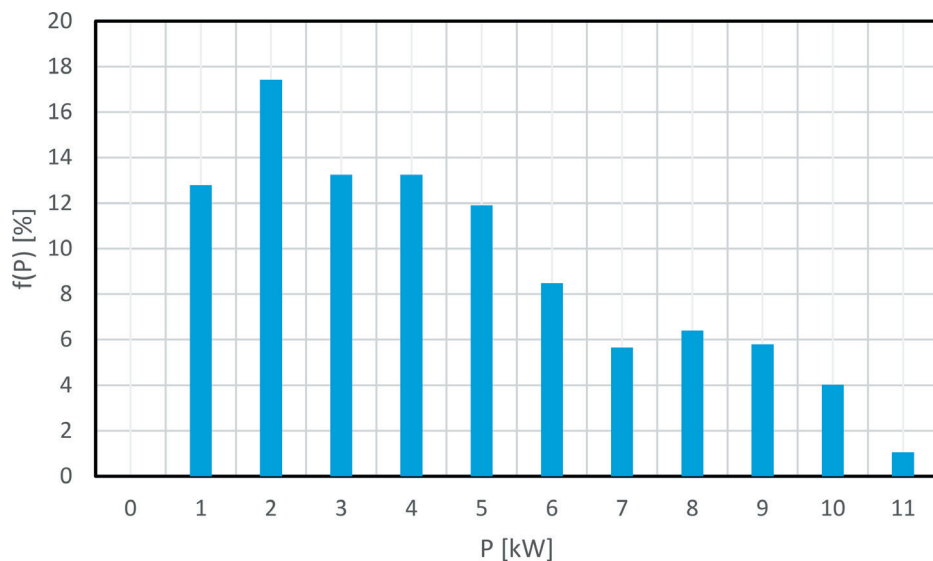

Figure 27. Frequency distribution of available power

Quedas vs caudais e a distribuição de frequência do potencial energético disponíveis numa válvula redutora de pressão (PRV) estão apresentados nas Figuras 26 e 27

A substituição de uma PRV por uma MHP pode ter o efeito de alterar o estado do sistema, e esta modificação deve ser profundamente analisada a fim de evitar pressões excessivas ou abaixo do mínimo no resto da rede.

The best solution in terms of network functionality should be the design of a MHP replacing exactly the PRV working conditions existing in the dissipation node. In this way the process of energy recovery would not modify the hydraulic conditions of the network. Unfortunately, the small EPDs described in Chapter 4 are not equipped with an embodied regulator, like the traditional turbines, and their characteristic curves do not fit the operating conditions in the dissipation node. This is quite clear in Figure 28a. The characteristic curve of an EPD connected to an asynchronous generator depends on the number of poles. For a given rotational speed, N , an operating condition could stand in the $H(Q)$ plane on the left or on the right of the characteristic curve. In the first case, the EPD would produce a head drop lower than requested by the pressure management, while, in the second case, the head drop would be larger. Only occasionally the EPD working condition could fit the WD operating conditions. Therefore, the replacement of a PRV with an MHP could have the effect of changing the system status, and this modification must be deeply analyzed in order to avoid excess pressures, or pressure below the minimum in the rest of the network.

In order to solve this problem, an external regulation of the EPD is required and three possibilities exist (see Figure 29). In the Hydraulic Regulation (HR), two automatic valves are required, the first in series with the EPD, and the second on a bypass pipeline. The principle will be clear observing Figure 28 (left). The first valve produces an additional head drop when the operating point is placed on the left of the EPD characteristic curve. The second valve opens the bypass when the operating point is placed on the right of the EPD characteristic curve. In the Electrical Regulation (ER), the WD operating point and the EPD working point are matched by varying the rotational speed of the EPD with the use of an inverter, see Figure 28 (centre). Finally, a combined regulation (HER) is also possible, see Figure 28 (right).

For the large fluctuations of flow rate and pressure drop in the

WDNs, determined by the variability of the user demand, the only variation of the EPD speed is not sufficient to cover the whole range of operating conditions. Therefore, a mixed HER would be necessary. Previous studies demonstrated that the increase of MHP production obtained with the HER, compared to use of the HR, is not large enough to balance larger plant costs [5].

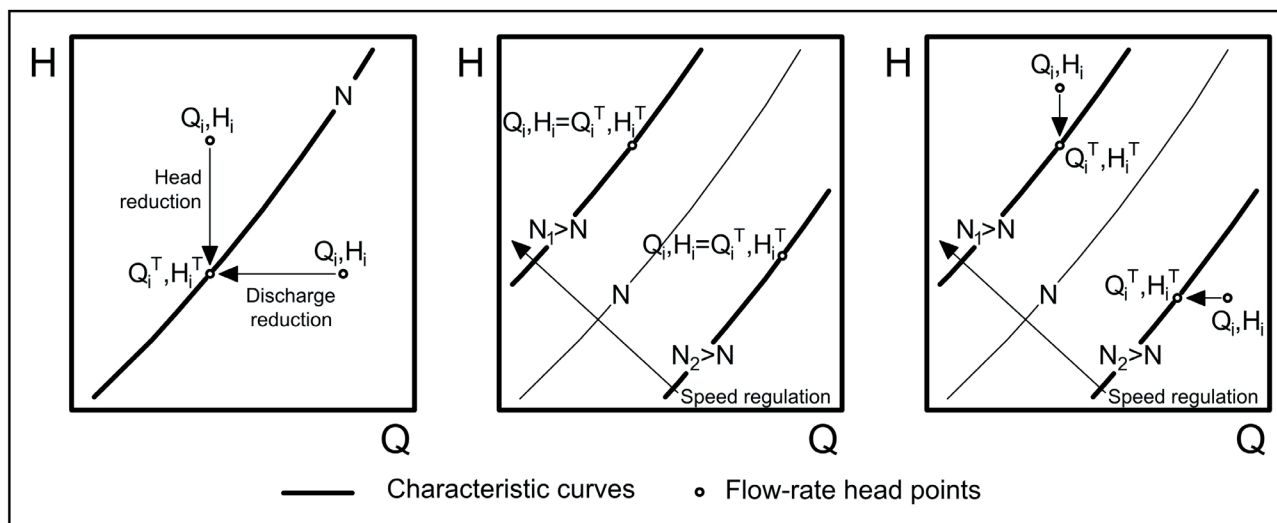

Figure 28. Regulation of the MHP in different cases: HR (left), ER (centre) and HER (right) – (<https://doi.org/10.1016/j.proeng.2014.02.031>)

Figura 28. Regulação da micro turbina (MHP) para evitar pressões excessivas, ou pressão abaixo do mínimo na restante rede.

Figura 29. Esquema
central micro hídrica

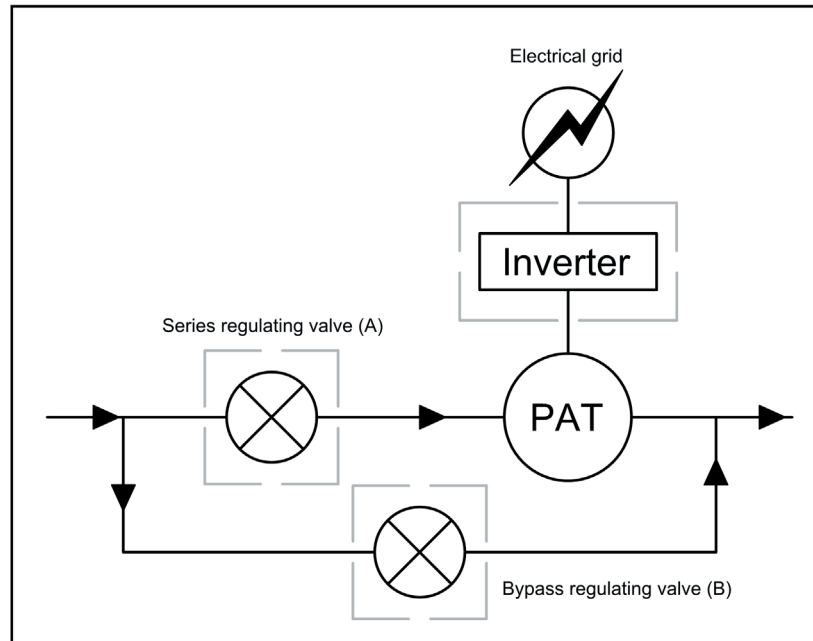

Figure 29. Hydropower plant scheme
(<https://doi.org/10.1016/j.proeng.2014.02.031>)

7. Principles of MHP design

In the design of the MHP the following aspects are prevalent: the reliability, the unitary cost, and the availability of the design data. Just in case of Low power/Low production EPDs these aspects become of little relevance, because the presence of the MHP does not affect the WD status significantly, and the choice can be performed based on the needs of the monitoring and control station. For high reliability and low cost, the use of PATs can be preferred.

PAT selection in conventional MHP

One limitation to the exploitation of the PAT technology was represented by resistance of the pump producers to publish in their catalogues the characteristic and performance curve in reverse mode. Therefore, in the literature a large number of studies was focused on the theoretical prediction of PAT working conditions based on the pump working conditions. The REDAWN project tried to overcome this problem by assembling a database of commercial PATs in order to simplify the PAT choice and to place the MHP design on a more solid basis. The database contains the performance curves of the industrial pumps operating in direct or reverse mode. An user friendly code is available on the REDAWN website as a support tool for an easy access to the database (<https://www.redawn.eu/>).

The second aspect in the design is represented by the choice of the model and of the size of the PATs. The Variable Operating Strategy (VOS) is the most diffuse PAT design strategy given in the technical literature. VOS is an iterative selection algorithm, evaluating the model and size of the PAT which maximizes an objective function, usually represented by the MHP effectiveness, in terms of plant productivity and component reliability. A numerical code, given as a support tool on the REDAWN website (<https://www.redawn.eu/>), was created implementing VOS on the PAT database.

Princípios para o projecto de micro hídricas (MHP)

A Estratégia Operacional Variável (VOS) é a estratégia de projecto para as PATs com maior divulgação, avaliando o modelo e o tamanho do PAT que maximiza a eficácia da micro hídrica (MHP).

Starting from the MHP working conditions in a selected point of the network, and on an imposed value of the backpressure, the selection of the PAT is performed and the energy generated by the MHP is determined.

Unconventional MHP

A different design procedure is necessary for the design of MHP used for a direct energy supply from a freshwater stream to another water stream (freshwater or wastewater). In both cases a complete theory was developed during the REDAWN project and is now available in the technical literature [14,28]. The direct transfer occurs by means of a special device where a PAT is directly coupled with a pump and the mechanical transmission occurs along the same shaft of the two machines. Thus, the PAT converts the available hydraulic power into mechanical power and its rotating shaft is directly connected to another machine to pump the water in another pipeline. The condition for this form of energy recovery is the presence of a specific site where an excess of energy is present on the main pipeline of the WSN and an energy supply is required on a secondary branch of the same network or on a branch of a different network (e.g. wastewater network). The first case, PAT-Pump (P&P) is represented in Figure 30, while the second case, Mixed PAT-Pump (MP&P), is reported in Figure 31. In the first case, the same time distribution of the two flow rates pattern can be assumed and the peak hour of the two parts of the network coincides. In the latter case, instead, the pattern of the wastewater network is usually delayed and a lag can exist between the peak demand in the WDN (i.e. the maximum turbinized discharge) and the peak flow rate in the wastewater network (i.e. the maximum pumped discharge).

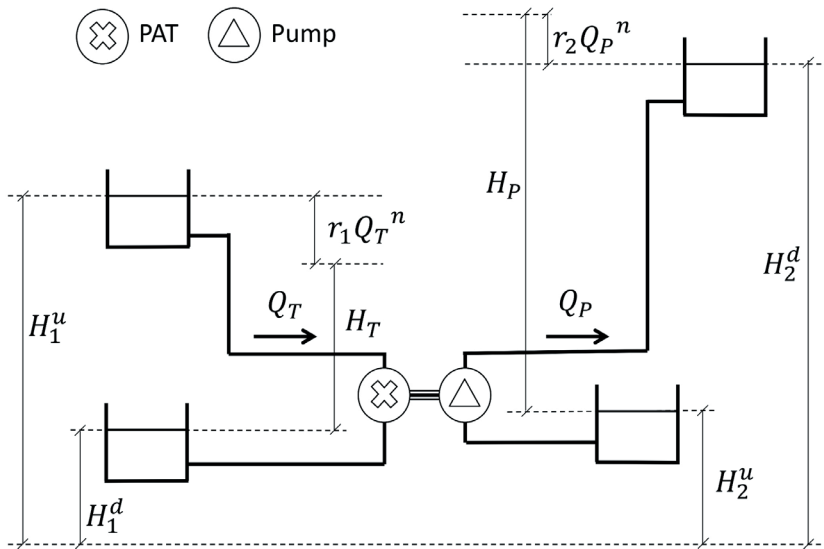

Figure 30. Hydraulic scheme of a PAT-Pump turbocharger - P&P
(<https://doi.org/10.3390/w9010062>).

Figura 30.
Esquema hidráulico
de uma
turbine-bomba
(PAT-Pump - P&P)

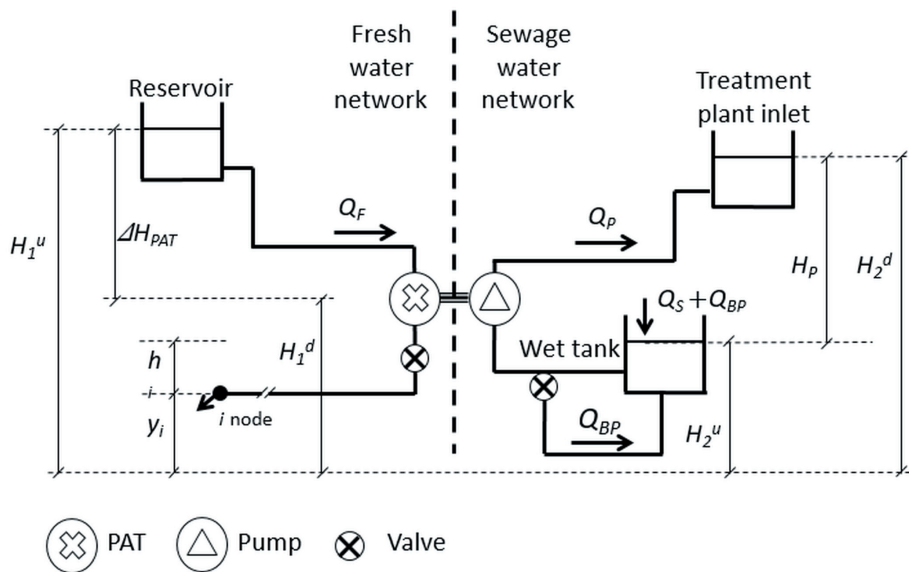

Figure 31. Hydraulic scheme of Mixed PAT-Pump - MP&P
(<https://doi.org/10.3390/w12010038>).

A teoria de acoplar uma PAT com uma Bomba (MP&P), com uma transferência de energia da água doce para o fluxo de águas residuais, foi inteiramente desenvolvida dentro do projeto REDAWN

In the first case, this kind of plant is viable when the available energy is related to high flow rate (Q_T) and low head (H_T), while in the second part of the network a smaller flow rate (Q_p) must be pumped with higher pumping head (H_p). The study [28] demonstrated that up to one third of the turbined discharge can be pumped ($Q_p/Q_T < 0.33$), while the pumping head can be up to 4.5 times the turbined head ($H_p/H_T < 4.5$). The efficiency of the energy conversion can be up to 0.45, which means that up to the 45% of the available power can be used to pump the water in the second part of the network.

The theory of the MP&P plant, with an energy transfer from the freshwater to the wastewater stream, has been entirely developed within the REDAWN project, with an application to the small Irish village located in County Laois, about 100 km from Dublin (IE). In Figure 32, the two networks are represented. On the left, the red arrows represent the freshwater supply to the end users. In the right-side network, instead, the wastewater is collected and follows the slopes according to the blue arrows. The collection point of the wastewater network coincides with the location of the MHP on the freshwater network, which is supposed along the link 8-10, replacing an existing PRV valve. Then, from this location the wastewater must be pumped towards the treatment plant. The available discharge, head drop and power of the MHP plant are shown in Figure 33. The turbo compressor for this MHP could be represented by a PAT coupled with a bareshaft wastewater pump.

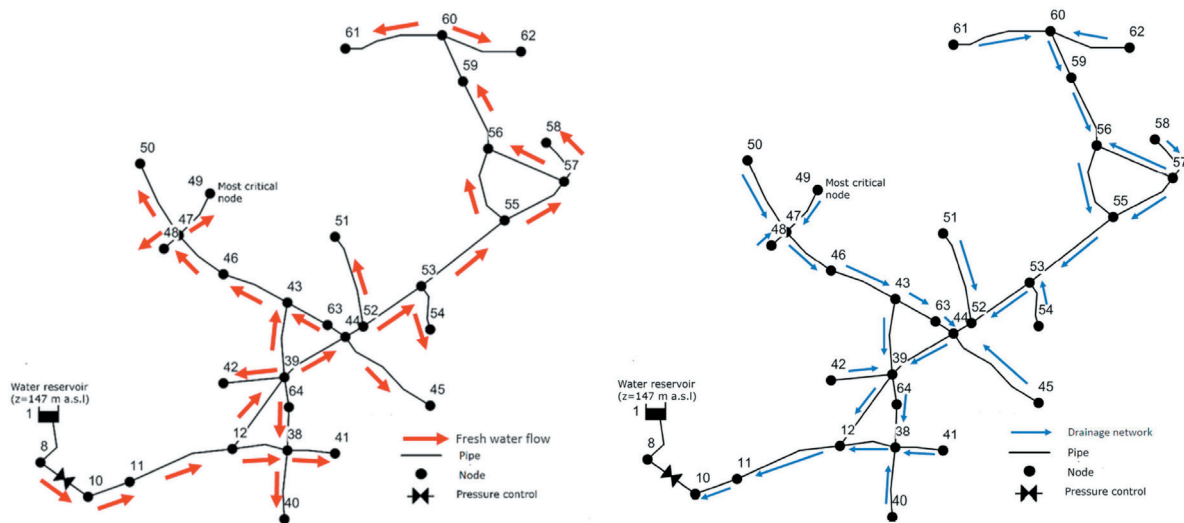

Figure 32. Freshwater and wastewater networks of County Laois (IE) – (<https://doi.org/10.3390/fluids3020041>)

A teoria do projeto MP&P foi aplicada às redes de água doce e residuais do Município de Laois (IE)

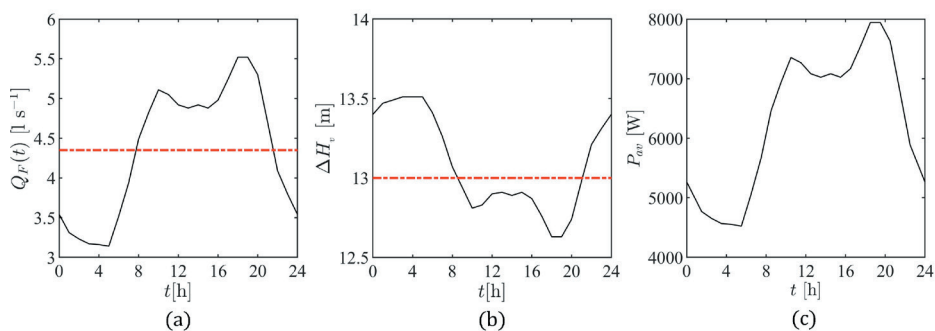

Figure 33. Time series of flow (a), head loss (b) and available power (c) through the valve located in link 8–10 (<https://doi.org/10.3390/fluids3020041>).

A transferência de energia da rede de água doce para a rede de águas residuais permite diferentes Alturas de elevação no sistema de bombeamento de águas residuais, dependendo do coeficiente de escoamento.

The crucial aspect in the design of this kind of MHP is the time lag between the pattern of the freshwater flow rate and the pattern of the wastewater discharge. This lag is due to the characteristics of the wastewater network, which affect the velocity of the water stream. The wastewater flow distribution can be determined from the freshwater flow distribution by a hydrological model, depending – among the others variables – on the runoff coefficient ϕ . Then, the design of the MHP plant can be performed by a set of three equations, using the average flow rate of the fresh and wastewater hydrographs.

The results of the design phase are clearly represented in Figure 34. The energy transfer from the freshwater to the wastewater network allows different pumping head in the wastewater pumping system, depending on the runoff coefficient. For the available power in the dissipation node of link 8-10 the possible pumping head in the pumping station was found to vary between 1.6 m and 3.3 m.

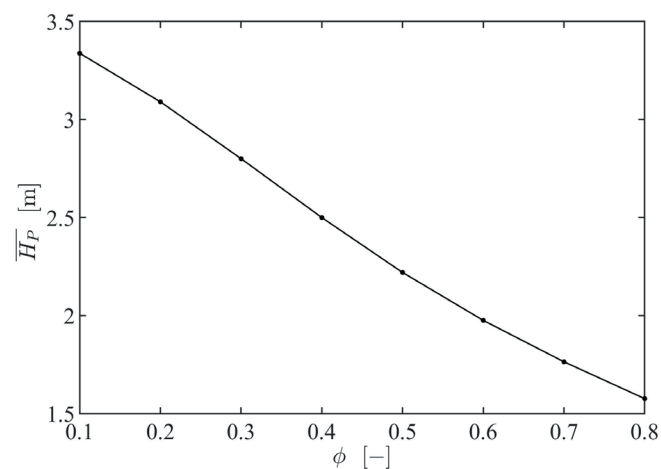

Figure 34. Daily averaged pressure head against runoff coefficient (ϕ) - (<https://doi.org/10.3390/fluids3020041>).

MHP layout and housing

The viability of an MHP in a water distribution network is strictly connected with the total plant cost, including EPDs, piping, control valves, electric components, housing, grid connection and maintenance. Considering the small available power, and the connected small annual revenue, these costs have to be strictly controlled. A positive Net Present Value is possible for the presence in many cases of favourable design conditions. The use of PATs is the most suitable solution to contain the EPD costs. The cost of the electric components can be minimised by using a fixed PAT speed, with energy produced at the grid frequency with an asynchronous generator. The cost of the piping and of the control valve is still a significant expense in the list of costs, in presence of the flow rate and head drop variability of the WD. In many cases, along the main WDN pipelines the MHP can be placed in a large existing manhole or in the chamber of a supply tank, reducing the cost of housing. Grid connection is also granted in most of the urban sites. Finally, the cost of plant maintenance, which at present can be only estimated for the absence of a previous experience, should be much reduced by the exclusive use of reliable industrial components [31].

The problem of the plant viability of Hydropower plant equipped with Low power/High production EPDs becomes puzzling when just a single one of the previous conditions is absent. A classical case is the absence of a grid connection in the dissipation node, or the lack of any kind of manhole for the power plant housing. The only way to overcome this kind of problems is the research of a local use of the energy and a reduced size of the plant.

Another complex situation is represented by the diffuse energy recovery in the peripheral branches of the network in presence of an available power as small as 1 kW, a large fluctuation of flow rate and pressure drop, and very small revenues of the hydropower plant. The research can be of help in finding new solutions for these extreme conditions. One possibility is represented by the use of PATs

A viabilidade de uma micro hídrica (MHP) numa rede de distribuição de água está estritamente ligada ao custo total da central, incluindo EPDs, tubagens, válvulas de controle, componentes elétricos, central, ligação à rede e manutenção.

O sistema Single Series-Parallel (SSP) para micro hídricas foi recentemente proposto para a área residencial a fim de reduzir o custo da instalação

without a complete regulation system. The Single Series-Parallel (SSP) system for hydropower plants has been recently proposed for residential area, using two PATs and three simple ON/OFF valves (see Figure 35). By an alternative use of the valves, the two PATs can work in parallel or in series, covering a wide range of local operating conditions (see Figure 36). The SSP represented a simplified solution for a PRV replacement, considering that the PATs working conditions do not match the required operating conditions. Therefore, the backpressure is not fully guaranteed, but it is obtained only approximately. This solution increases the plant revenue, for the wide range of flows where the production of energy is possible, and reduces the plant cost, for the absence of a complete regulation system.

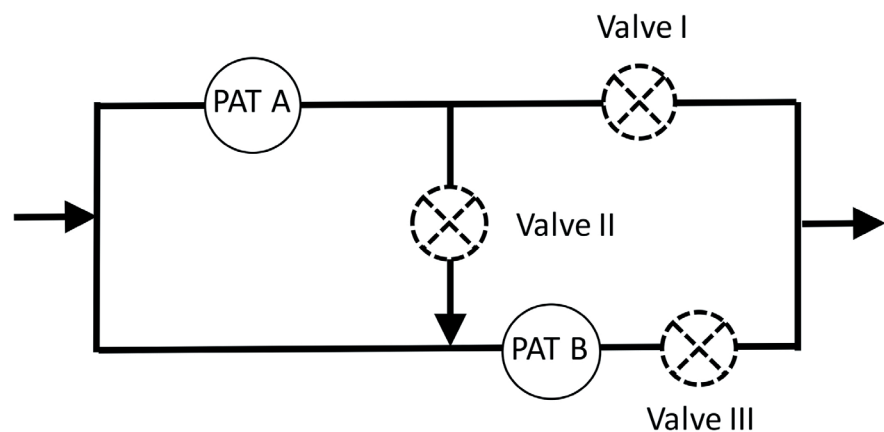

Figure 35. Single, series or parallel PATs system
(<https://doi.org/10.1016/j.renene.2018.02.132>)

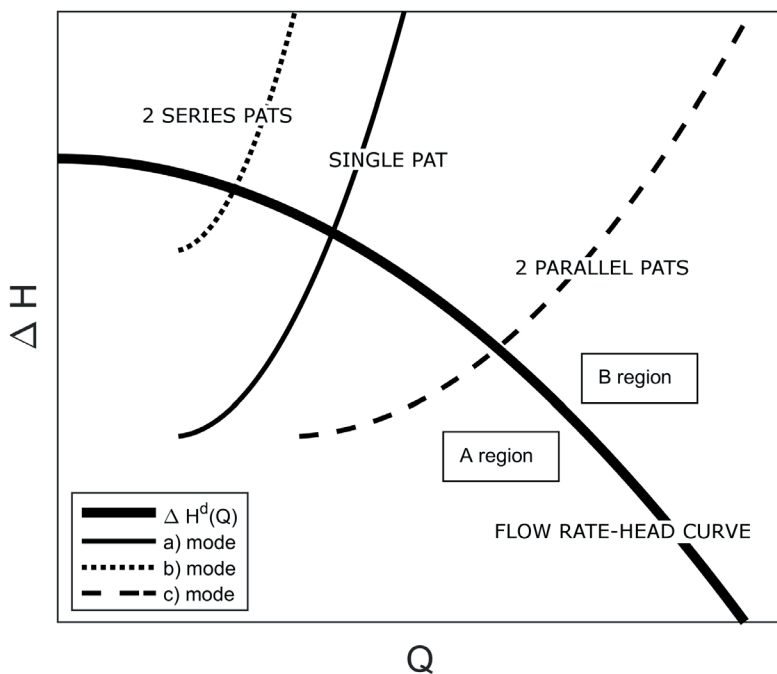

Figure 36. Working conditions of the SSP system
(<https://doi.org/10.1016/j.renene.2018.02.132>)

A further refinement of the SSP system has been proposed, realized and tested within the REDAWN project. The Energy Booster, represented in Figure 14, is a compact SSP system using semi-axial submersed pumps as PATs, placed in a booster. The advantage of this system is the complete isolation of the power plant and the facility of MHP housing.

MHP location strategy

In complex water distribution networks, the optimal location of hydropower plants in the framework of a pressure reducing strategy is a complex task. It is important to stress from the very beginning that

Outro refinamento do sistema SSP é o Energy Booster (compressor de energia), totalmente realizado e testado dentro do projeto REDAWN

Um modelo de
otimização numérica
é a melhor forma de
identificar a
localização ideal de
válvulas e de MHPs.

this problem cannot be solved by a complete uncontrolled numerical algorithm. The number of states of the network and the number of variables is too large in the real system even for the most advanced optimization techniques. Obviously, for a practical purpose these techniques will not be used on the complete network and a simplified strategy must be used.

The first possibility is to use a two steps procedure: i) finding the optimal location of the dissipation nodes; ii) evaluating the economic viability of a PRV replacement with a PATs. This technique is probably the most reasonable, considering that the main economic advantage of a pressure reducing strategy basically comes from the reduced cost of water due to the leakage containment rather than the energy production. However, the research on the optimal location of the dissipation nodes is really advanced and numerical codes are already available for a practical use [25].

A second possibility is to find a reasonable location of the hydro-power plant by using a heuristic approach. This alternative is much more effective in presence of a network management based on the identification of District Meter Areas (DMAs) with well controlled pressure patterns and water flow monitoring, in order to reduce water losses and to optimize the water systems management. The DMAs are defined on the basis of a number of topographic, hydraulic and social conditions. Then the water network loops are simplified by isolating the DMAs, reducing to a minimum the inflow and outflow between the DMAs. As a consequence, the problem of the optimal location is reduced in N different problems, N being the number of DMAs.

Once the complexity of the problem of the PAT optimal location has been reduced, a numerical optimization model can be considered the best way to identify the optimal location of valves and MHPs. Some advanced optimization models have been developed during the REDAWN project, which consider the whole network and the whole daily demand pattern [25]. One of the proposed mo-

dels is designed to find the optimal location of hydraulic devices, considering both the water saving and the energy production. The idea behind the model is that the water distribution networks are complex systems, where any modification could affect the behaviour of the whole network. Moreover, in certain locations the use of a MHP can be a viable solution to both to reduce pressure and produce energy, but, in other cases, the reduction of pressure could produce large water savings but small energy recovery: there a valve can be more convenient than a turbine. The objective of the proposed model is the maximization of the revenue of the investment cost for the placement of PATs and valves. Figure 37 shows the obtained optimal locations of pumps, valves and turbines in a synthetic water network: the yearly income due to energy production and water saving in the study case, related to the input volume of the network, can be 0.036 €/m³/year.

In many cases, a two-step design will be necessary. In the first step, an approximate solution will be found, which maximizes the Net Present Value of the hydropower plants installation, based on a simplified MHP layout. The solution of the model is the available discharge and head jump. Then, based on these values, the final MHP layout will be obtained by a refinement of the preliminary solution, with the application of the design procedure presented above.

Em muitos casos, um projeto de duas etapas é suficiente. Na primeira etapa, será encontrada uma solução aproximada, que maximize o Valor actualizado Líquido da instalação, com base num layout de MHP simplificado. Só depois o layout final da MHP será obtido com um refinamento da solução preliminar, com a aplicação do procedimento de projeto VOS.

Figura 37.
 Localização ideal de
 bombas, turbinas e
 válvulas em uma
 rede sintética

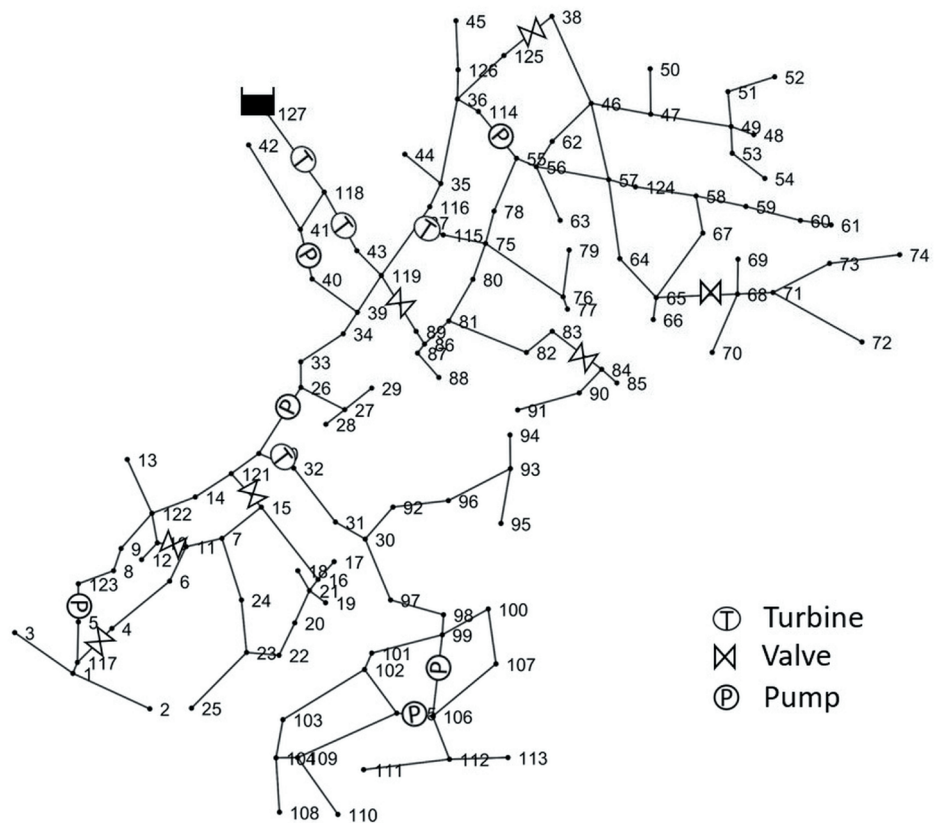

Figure 37. Optimal location of pumps, turbines and valves in a synthetic network (Morani M.C., PhD Thesis, Newly proposed strategies to increase the energy efficiency of water systems, University of Naples “Federico II”, 2021)

8. Environmental benefit of MHP

In addition to the potential economic benefit of the energy recovery, the implementation of the MHP technology determine several potential environmental benefits. In some cases, the potential environmental benefit itself could represent a good motivation for the MHP installation, considering the increasing interest on the environment at a political and social level.

According to several studies made by IDAE, hydroelectric generation is the energy system producing the lowest impacts on the environment per kWh generated, including renewable sources.

The following positive environmental effects of MHPs can be identified:

1. Greenhouse gas emissions are reduced, resulting in a lower incidence on global warming and climate change;
2. The use of water is non-consumptive since the water used is not consumed, but rather is returned to the natural environment without alteration of water properties;
3. The installed equipment does not affect the properties of the water stream;
4. The energy is used locally, reducing the environmental impacts of any type of energy transport;
5. The environmental impact is reduced due to the contained size of MHP plants, compared to the traditional hydropower plants;
6. MHPs do not produce polluting waste, except in the construction phase, which must always be followed by preventive and corrective measures;

Benefícios ambientais de uma MHP

De acordo com diversos estudos, a geração de energia hidroelétrica é o sistema energético que produz os menores impactos ao meio ambiente por kWh gerado, incluindo fontes renováveis.

7. Compared to other technologies, in MHP plants the equipment whose manufacture involves smaller volume of hazardous substances and smaller waste generation is used;
8. The energy production is endless, thanks to the natural hydrological cycle;
9. The risk of soil saturation due to pipe breaks is reduced since MHP plants operate as pressure-reducing elements.

In general, the realization of a traditional hydropower plant includes the following actions:

1. Conditioning of roads.
2. Mulching and earthworks (depending on the work size).
3. Placement of pipes and construction of manholes.
4. Laying of electrical line.
5. Filling of excavation holes.
6. Construction of buildings to house electromechanical equipment.
7. Transport, storage and assembly of electromechanical equipment, causing strong environmental impacts.

The main potential effects are following presented:

1. Release of substances, energy or noise (accidental release of chemicals by construction machinery or during maintenance works; emission of noise and vibrations by use of machinery).
2. Soil, air and water pollution (loss of air quality due to the emission of combustion gases and dust produced by construction machinery; water and soil pollution due to accidental spills).

3. Destruction of vegetation, landscapes, habitats and fauna (e.g. higher erosive capacity of the water channel and alteration of aquatic ecosystems owing to flow variation; deposition materials; water barrier effect determined by dams; erosion and degradation of soil and loss of vegetation cover by earthworks and excavations; habitat loss due to the removal of vegetation and flooding over large areas after the construction of dams; dislocation of susceptible species due to noises; visual impact due to landscape mutation caused by new infrastructures).

The integration of a MHP plant in any hydraulic infrastructure requires only steps 3 to 7 above and in a much smaller size, hence having a lower incidence on the environment. The impacts are minimized as a result of a smaller volume of excavation and of less heavy machinery movement. Since MHPs are not located in natural channels, these do not determine the alteration of the natural environment. MHP plants also prevent the disruption of water stream or the barrier effect due to the construction of dams or weirs. In addition, the loss of habitat due to the river flooding over large areas is avoided.

However, during the plant operation, some environmental impacts typical of any hydropower plant should be taken into consideration, even though these occur on a smaller scale:

1. Energy or noise release (emission of noises and vibrations by turbine operation; emission of electromagnetic radiation by power lines).
2. Soil and water pollution for accidental release of chemicals during maintenance works. In case of MHP plants within water supply networks, the risk of contamination of drinking water due to the dilution of toxic chemicals should be also considered. To overcome this risk, it is

Uma vez que as MHPs não estão localizados em canais naturais (tipos rios, ou ribeiras), elas não determinam a alteração do ambiente natural.

Os resultados do benefício potencial ambiental em países da área Atlântica (AA) são relatados na Figura 38

needed that the elements in contact with the water stream should receive the treatments provided by the legislation and that the lubrication circuits of moving parts do not produce dangerous leaks.

With regard to the environmental benefits on the hydraulic infrastructures, the installation of MHP plants allow to reduce the external electrical supply, but rather a self-supply is guaranteed by the exploitation of the energy embedded in the water stream itself. As a result, the operating costs, as well as the carbon footprint of the installation, are significantly reduced. For a general assessment of the environmental benefit of the MHP technology in the AA, the carbon footprint has been assessed according to the MHP potential in each country. Since MHP plants produce electricity without greenhouse gas emissions, the reduction of CO₂ has resulted equivalent to the electrical energy generated according to the electrical mix of each country.

The results of the environmental potential benefit are reported in Figure 38.

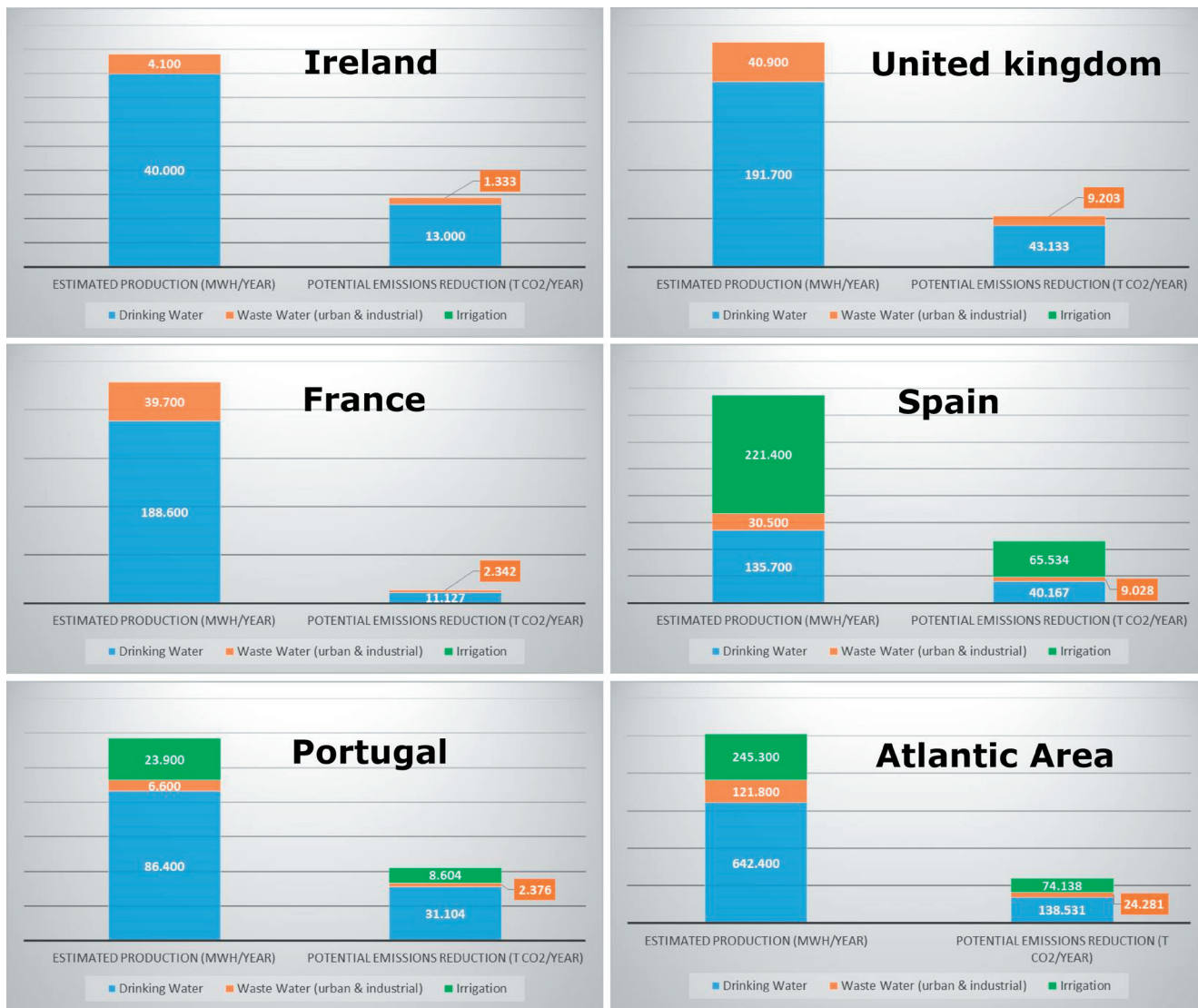

Figure 38. Potential environmental benefit in the AA countries

9. Conclusions

REDAWN project was focused on the exploitation of the micro-hydropower energy recovery in the water sector, including drinking water, wastewater, industry and irrigation networks, within the Atlantic Area of Europe. The knowledge of many fundamental aspects of the PAT technology has been acquired and support tools for the design of MHP plants have been developed.

This booklet depicts the opportunities of the energy recovery in the WDNs of the AA, states the potential economic and environmental impact of the MHP implementation and specifies the guidelines for the design of MHPs in the water supply networks. These guidelines will allow policy makers, water managers and technicians to deeply understand the importance of the energy recovery inside a more comprehensive strategy for the limitation of the energy use in water transportation and distribution. In the framework of the water-energy-food nexus, the reduction of pressure within networks by means of a correct pressure management is an effective strategy to contain the waste of energy and water. The control of pressure can be obtained by the installation of pressure reducing valves within the network. Unlike such valves, a micro hydropower plant allows to control pressure, thus leakage, and also recovers energy. Furthermore, MHPs are perfectly viable in terms of reliability and costs. A correct design will be possible starting from a deep analysis of the network conditions, in terms of energy use, hydraulic state, and network control. In many cases, a sustainable use of the recovered energy is the insightful condition for the choice of the hydropower plant configuration.

10. References

- [1] Besharat, M., Dadfar, A., Viseu, M. T., Brunone, B., & Ramos, H. M. (2020). Transient-flow induced compressed air energy storage (TI-CAES) system towards new energy concept. *Water*, 12(2), 601
- [2] Capelo, B., Pérez-Sánchez, M., Fernandes, J. F., Ramos, H. M., López-Jiménez, P. A., & Branco, P. C. (2017). Electrical behaviour of the pump working as turbine in off grid operation. *Applied Energy*, 208, 302-311.
- [3] Carravetta, A., Fecarotta, O., & Ramos, H. M. (2018). A new low-cost installation scheme of PATs for pico-hydropower to recover energy in residential areas. *Renewable Energy*, 125, 1003-1014.
- [4] Carravetta, A., Fecarotta, O., Ramos, H. M., Mello, M., Rodriguez-Diaz, J. A., Morillo, J. G., ... & McNabola, A. (2018). Reducing the Energy Dependency of Water Networks in Irrigation, Public Drinking Water, and Process Industry: REDAWN Project. In *Multidisciplinary Digital Publishing Institute Proceedings (Vol. 2, No. 11, p. 681)*.
- [5] Carravetta, A; Houreh, S.D; Ramos, H.M. *Pumps as Turbines: Fundamentals and Applications*, Springer, 2018.
- [6] Chacon, M. C., Díaz, J. A. R., Morillo, J. G., & McNabola, A. (2020). Hydropower energy recovery in irrigation networks: Validation of a methodology for flow prediction and pump as turbine selection. *Renewable Energy*, 147, 1728-1738.
- [7] Chacón, M. C., Díaz, J. A. R., Morillo, J. G., & McNabola, A. (2020). Estimating regional potential for micro-hydropower energy recovery in irrigation networks on a large geographical scale. *Renewable Energy*, 155, 396-406.

- [8] Chacón, M. C., Díaz, J. A. R., Morillo, J. G., & McNabola, A. (2021). Evaluation of the design and performance of a micro hydropower plant in a pressurised irrigation network: Real world application at farm-level in Southern Spain. *Renewable Energy*, 169, 1106-1120.
- [9] Chacón, M. C., McNabola, A., Hydropower energy recovery potential from irrigation networks, Presented at ENVIRON2018, Cork, Ireland.
- [10] Chacón, M. C., Rodríguez-Díaz, J. A., Morillo, J. G., Gallagher, J., Coughlan, P., & McNabola, A. (2018). Potential Energy Recovery Using Micro-Hydropower Technology in Irrigation Networks: Real-World Case Studies in the South of Spain. In *Multidisciplinary Digital Publishing Institute Proceedings* (Vol. 2, No. 11, p. 679).
- [11] Cimorelli, L., & Fecarotta, O. (2020). Optimal Regulation of Variable Speed Pumps in Sewer Systems. In *Environmental Sciences Proceedings* (Vol. 2, No. 1, p. 58). Multidisciplinary Digital Publishing Institute.
- [12] Crespo Chacón, M., Rodríguez Díaz, J. A., García Morillo, J., & McNabola, A. (2019). Pump-as-turbine selection methodology for energy recovery in irrigation networks: Minimising the payback period. *Water*, 11(1), 149.
- [13] Fecarotta, O., & Cimorelli, L. (2021). Optimal scheduling and control of a sewer pump under stochastic inflow pattern. *Urban Water Journal*, 1-11.
- [14] Fecarotta, O., Martino, R., & Morani, M. C. (2019). Wastewater pump control under mechanical wear. *Water*, 11(6), 1210.
- [15] Fecarotta, O., Messa, G. V., Pugliese, F., Carravetta, A., Malavasi, S., & Giugni, M. (2018). Preliminary development of a method for impact erosion prediction in pumps running as turbines. In *Multidisciplinary Digital Publishing Institute Proceedings* (Vol. 2, No. 11, p. 680).

- [16] Fernandes, J. F., Pérez-Sánchez, M., da Silva, F. F., López-Jiménez, P. A., Ramos, H. M., & Branco, P. C. (2019). Optimal energy efficiency of isolated PAT systems by SEIG excitation tuning. *Energy Conversion and Management*, 183, 391-405.
- [17] Fontanella, S., Fecarotta, O., Molino, B., Cozzolino, L., & Della Morte, R. (2020). A Performance Prediction Model for Pumps as Turbines (PATs). *Water*, 12(4), 1175.
- [18] Giudicianni, C., Herrera, M., di Nardo, A., Carravetta, A., Ramos, H. M., & Adeyeye, K. (2020). Zero-net energy management for the monitoring and control of dynamically-partitioned smart water systems. *Journal of Cleaner Production*, 252, 119745.
- [19] Manna, M., Vacca, A., & Verzicco, R. (2020). Pulsating spiral Poiseuille flow. *Journal of Fluid Mechanics*, 890.
- [20] Mérida García, A., Rodríguez Díaz, J. A., García Morillo, J., & McNabola, A. (2021). Energy Recovery Potential in Industrial and Municipal Wastewater Networks Using Micro-Hydropower in Spain. *Water*, 13(5), 691.
- [21] Mitrovic, D., Antonio, J., Diaz, R., Morillo, J. G., Coughlan, P., Gallagher, J., & McNabola, A. (2018). Hydropower energy recovery in water pipe networks: spatial regression analysis using GIS, assessing the correlation between energy recovery potential and geographical data. *Proceedings of the Water Efficiency Conference 2018, 5-7 September 2018, Aveiro Portugal: WATEF Network/ University of Bath*
- [22] Mitrovic, D., Chacón, M. C., García, A. M., Morillo, J. G., Diaz, J. A. R., Ramos, H. M., ... & McNabola, A. (2021). Multi-Country Scale Assessment of Available Energy Recovery Potential Using Micro-Hydropower in Drinking, Pressurised Irrigation and Wastewater Networks, Covering Part of the EU. *Water*, 13(7), 899.

- [23] Mitrovic, D., McNabola, A., Hydropower energy recovery potential of water distribution networks: Assessing the correlation between the potential and geographical data, Presented at ENVIRON2018, Cork, Ireland.
- [24] Mitrovic, D., Morillo, J. G., Rodríguez Díaz, J. A., & McNabola, A. (2021). Optimization-Based Methodology for Selection of Pump-as-Turbine in Water Distribution Networks: Effects of Different Objectives and Machine Operation Limits on Best Efficiency Point. *Journal of Water Resources Planning and Management*, 147(5), 04021019.
- [25] Morani, M. C., Carravetta, A., D'Ambrosio, C., & Fecarotta, O. (2021). A new mixed integer non-linear programming model for optimal PAT and PRV location in water distribution networks. *Urban Water Journal*, 1-15.
- [26] Morani, M. C., Carravetta, A., D'Ambrosio, C., & Fecarotta, O. (2020). A New Preliminary Model to Optimize PATs Location in a Water Distribution Network. In *Environmental Sciences Proceedings* (Vol. 2, No. 1, p. 57). MDPI.
- [27] Morani, M. C., Carravetta, A., Del Giudice, G., McNabola, A., & Fecarotta, O. (2018). A comparison of energy recovery by PATs against direct variable speed pumping in water distribution networks. *Fluids*, 3(2), 41.
- [28] Morani, M. C., Carravetta, A., Fecarotta, O., & McNabola, A. (2020). Energy transfer from the freshwater to the wastewater network using a pat-equipped Turbopump. *Water*, 12(1), 38.
- [29] Morillo, J. G., Díaz, J. A. R., Crespo, M., & McNabola, A. (2018). Energy Saving Measures in Pressurized Irrigation Networks: A New Challenge for Power Generation. In *Multidisciplinary Digital Publishing Institute Proceedings* (Vol. 2, No. 23, p. 1440).
- [30] Morillo, J. G., McNabola, A., Camacho, E., Montesinos, P., & Díaz,

- J. R. (2018). Hydro-power energy recovery in pressurized irrigation networks: A case study of an Irrigation District in the South of Spain. *Agricultural Water Management*, 204, 17-27.
- [31] Novara, D., Carravetta, A., McNabola, A., & Ramos, H. M. (2019). Cost model for pumps as turbines in run-of-river and in-pipe microhydropower applications. *Journal of Water Resources Planning and Management*, 145(5), 04019012.
- [32] Perez-Sanchez, M., Sánchez-Romero, F. J., Ramos, H. M., & López-Jiménez, P. A. (2020). Improved planning of energy recovery in water systems using a new analytic approach to PAT performance curves. *Water*, 12(2), 468.
- [33] Pérez-Sánchez, M., Simão, M., López-Jiménez, P. A., & Ramos, H. M. (2017). CFD analyses and experiments in a PAT modeling: Pressure variation and system efficiency. *Fluids*, 2(4), 51.
- [34] Pienika, R., Usera, G., & Ramos, H. M. (2020). Simulation of a Hydrostatic Pressure Machine with Caffe3d Solver: Numerical Model Characterization and Evaluation. *Water*, 12(9), 2419.
- [35] Ramos, H. M., McNabola, A., López-Jiménez, P. A., & Pérez-Sánchez, M. (2020). Smart water management towards future water sustainable networks. *Water*, 12(1), 58.
- [36] Ramos, H. M., Pérez-Sánchez, M., Franco, A. B., & López-Jiménez, P. A. (2017). Urban floods adaptation and sustainable drainage measures. *Fluids*, 2(4), 61.
- [37] Ramos, H. M., Simão, M., McNabola, A., Novara, D., & Carravetta, A. (2018). Fostering Renewable Energies and Energy Efficiency in the Water Sector Using PATs and Wheels. In *Multidisciplinary Digital Publishing Institute Proceedings (Vol. 2, No. 23, p. 1438)*.
- [38] Ramos, H. M., Zilhao, M., López-Jiménez, P. A., & Pérez-Sánchez, M. (2019). Sustainable water-energy nexus in the optimization of the BBC golf-course using renewable energies. *Urban Water Journal*, 16(3), 215-224.

- [39] Simão, M., Besharat, M., Ramos, H.M; (2018) Energy recovery using PAT, Silva-Afonso A and Rodrigues-Pimental, C. (Eds), Proceedings of the Water Efficiency Conference 2018, 5-7 September 2018, Aveiro Portugal: WATEF Network/ University of Bath.
- [40] Simão, M., Besharat, M., Carravetta, A., & Ramos, H. M. (2018). Flow velocity distribution towards flowmeter accuracy: CFD, UDV, and field tests. *Water*, 10(12), 1807.
- [41] Simão, M., Pérez-Sánchez, M., Carravetta, A., & Ramos, H. M. (2019). Flow conditions for PATs operating in parallel: Experimental and numerical analyses. *Energies*, 12(5), 901.
- [42] Simão, M., Pérez-Sánchez, M., Carravetta, A., López-Jiménez, P., & Ramos, H. M. (2018). Velocities in a centrifugal PAT operation: Experiments and CFD analyses. *Fluids*, 3(1), 3.
- [43] Stocks, C (2019) Micro hydropower and the Water Energy Food nexus, NS Energy 2020
- [44] Ueda, T., Roberts, E. S., Norton, A., Styles, D., Williams, A. P., Ramos, H. M., & Gallagher, J. (2019). A life cycle assessment of the construction phase of eleven micro-hydropower installations in the UK. *Journal of Cleaner Production*, 218, 1-9.

List of Abbreviations

AA	Atlantic Area
BAT	Best Available Technology
DH	Head drop
DMA	District Metered Area
EPD	Energy Production Device
ER	Electrical Regulation
HER	Hydraulic and Electrical Regulation
HR	Hydraulic Regulation
Hp	Pressure head of the pump
Ht	Head loss within the PAT
kW	Kilowatt
kWh	Kilowatt-hour
MHP	Micro hydropower
MP&P	Mixed PAT-Pump turbocharger
PAT	Pump as turbine
PRV	Pressure Reducing Valve
P&P	PAT-Pump turbocharger
Q	Flow rate
Qp	Flow rate through the pump
Qt	Flow rate through the PAT
SSP	Single Series Parallel
VOS	Variable Operating Strategy
W	Watt
WDN	Water Distribution Network
WSN	Water Supply Network
WTN	Water Transmission Network

REDAWN

Reducing Energy Dependency in Atlantic area Water Networks

Partners:

- Action Renewables
- Asociación Feragua de Comunidades de Regantes de Andalucía
- EDA Renováveis
- Empresa de Electricidade da Madeira
- Fundacion Asturiana de la Energia
- Hidropower Ltd
- Instituto Superior Técnico Lisboa
- Northern Ireland Water
- Nueces De Calonge
- Parceria Portuguesa para a Água
- Renova
- Syndicat Mixte de Production d'eau potable du Granvillais et de l'Avranchin
- Trinity College Dublin
- Universidad de Córdoba
- Università degli Studi di Napoli Federico II
- Water Efficiency Network (University of Bath)

